

# Connecting Telex VoIP Dispatch Systems to Analog Recorder Solutions



---

# Table of Contents

---

<b>1.0 General</b> .....	<b>3</b>
<b>2.0 HB-3+ Recorder Output NexusIP and C-Soft</b> .....	<b>3</b>
<b>3.0 C-6200 Recorder Output</b> .....	<b>4</b>
3.1 C-6200 Positional .....	4
3.2 C-6200 Per Line .....	4
3.2.1 TCRD .....	5
3.2.2 PCRD .....	6
<b>4.0 IP-1616 Recorder Output</b> .....	<b>6</b>
<b>5.0 IP-2002 Recorder Output</b> .....	<b>6</b>
<b>6.0 IP-223 Recorder Output</b> .....	<b>7</b>
6.1 IP-223 CTCSS Out Setup .....	7
6.1.1 IP-223 CTCSS Pin Setup. ....	7
6.1.2 IP-223 CTCSS Software Setup .....	7
6.2 IP-223 TX Out Setup .....	7
6.2.1 IP-223 Line TX Recorder Output Setup .....	8
6.2.2 IP-223 Multicast Address Setup .....	8
6.2.3.1 IP-223 Multicast Setup With Radios Example .....	8
6.2.4.2 IP-223 Multicast Setup with C-Soft Positional Recording Example .....	9
6.2.5.3 Positional Recording Setup .....	10

# Connecting Telex VoIP Dispatch System

## 1.0 General

This application note demonstrates the different methods of connecting analog recorder solutions with Telex Dispatch VoIP systems. When connected correctly, both positional as well as per line output recording is supported.

All consoles offer 600 Ohm balanced pair positional recorder outputs. Both select (microphone and primary line) and unselect (monitored lines not muted) outputs are supported.

## 2.0 HB-3+ Recorder Output NexusIP and C-Soft

The HB-3+ is the primary audio accessory interface for the Nexus IP and C-Soft consoles. Additionally, C-Soft can send positional audio, using an Ethernet packet stream, to the Telex Network Recording solution. Connecting an IP-223(s) to the LAN/WAN offers another solution if wiring from the console to a recorder is difficult.

The HB-3+ recorder outputs are shown in Figure 1. Connection to the recorder outputs, located on the back of the unit, are provided as push-on screw terminal blocks. The outputs are balanced 600 Ohm and adjustable through the HB-3+ cover.

The HB-3+ is shipped from the factory with unselect audio summed with select audio (REC OUT +/-) for single track recording.

To **remove unselect audio from the console output**, do the following:

- > Move **internal jumper JMP9** to the **B** position.

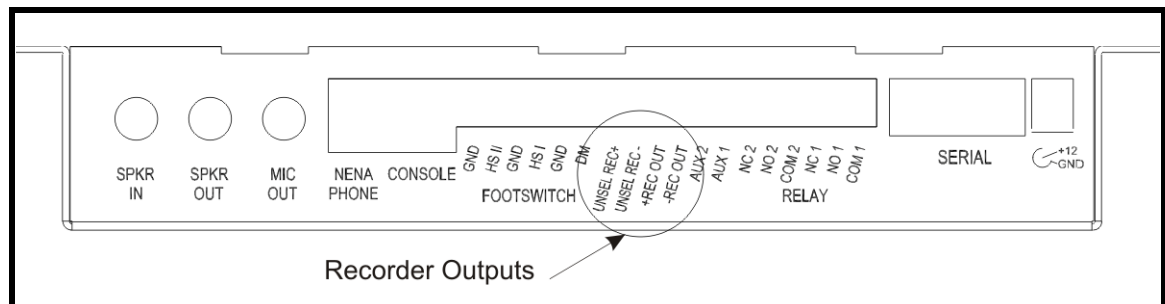

FIGURE 1. HB-3+ Recorder Outputs—Back Panel

## 3.0 C-6200 Recorder Output

The C-6200 is an 18-line console that supports both positional and per line recording capabilities when 6200 **TCRD** (Tone Card) or **PCRD** (Phone Card) optional line cards are installed.

### 3.1 C-6200 Positional

Positional recorder outputs are located on the main DB-25 connector located on the back of the C-6200. Select, unselect and crosspatch audio is supported on the C-6200 as balanced transformer coupled 600 Ohm pairs. Select recorder out is software adjustable. Unselect and crosspatch audio is sampled from speaker level.

Channel recorder outputs are located on the following pins:

- Select channel on pin 12 and pin 24
- Unselect channel on pin 11 and pin 23
- Crosspatch channel recorder outputs on pin 10 and pin 22

### 3.2 C-6200 Per Line

Per Line recording is supported on the individual TCRD or PCRD line card. The C-6200 can be configured to add Ethernet based RX traffic (RX from IP-223) to TCRD recorder outputs.

To **configure C-6200 Ethernet based RX traffic**, do the following:.

1. Open the **C-6200** web browser.
2. Click **Per Line Setup**.  
*The Per Line Setup window appears.*
3. Click the **line button** for the line to configure.
4. Select the **Sum Enet RX to TX** check box.

**REFERENCE:** For more information, see the C-6200 Radio Control Console Technical Manual (LIT000308000). This document is available for download at [www.telx.com/Downloads/](http://www.telx.com/Downloads/).

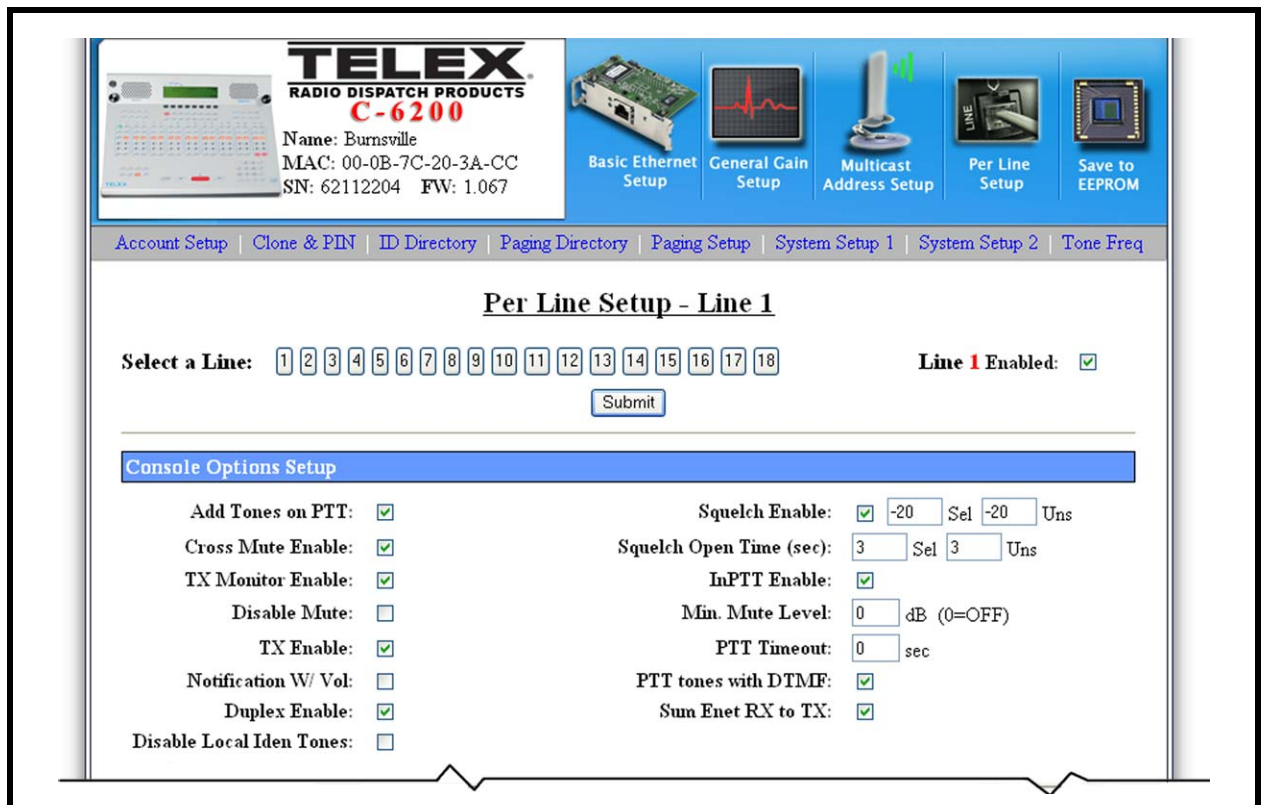

FIGURE 2. Per Line Setup

### 3.2.1 TCRD

The TCRD recorder I/Os, in the form of balanced transformer coupled 600 Ohm pairs, are situated on the DB-25 located on the back of the unit.

Output tie points, see Figure 3, are located:

- Line 1 recorder is on pin 13 and pin 25.
- Line 2 recorder is on pin 7 and pin 19.

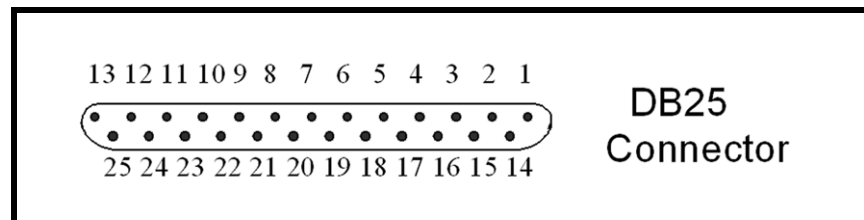

FIGURE 3. DB-25 Connector Pin Locations

### 3.2.2 PCRD

The PCRD recorder AUX I/Os, in the form of balanced transformer coupled 600 Ohm pairs, is located on an RJ-45 connector located on the back of the unit.

Output tie points, see Figure 4, are located:

- Line 1 recorder on pin 1 and pin 2.
- Line 2 recorder on pin 5 and pin 6.

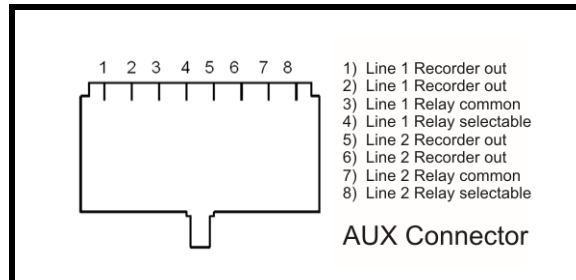

FIGURE 4. RJ-45 Connector Pin Outs

## 4.0 IP-1616 Recorder Output

The IP-1616 is an 8-line console that supports positional recorder outputs located on the main back panel DB-25. Select and Unselect audio is supported in the form of balanced transformer coupled 600 Ohm pairs. Select recorder output level is software adjustable. Unselect audio is sampled off speaker level.

Select channel recorder outputs are located:

- Select channel on pin 12 and pin 24.
- Unselect channel on pin 11 and pin 23.

## 5.0 IP-2002 Recorder Output

The IP-2002 is a 2-line console that supports positional recorder outputs on the RJ-45 located on the back of the unit. Line 1 and 2 audio is supported in the form of balanced transformer coupled 600 Ohm pairs. Both line outputs levels are software adjustable.

Recorder outputs are located:

- Line 1 on pin 1 and pin 2.
- Line 2 on pin 7 and pin 8.

## 6.0 IP-223 Recorder Output

The IP-223 is capable of supporting connections to analog recorders using two (2) methods.

First method:

- Pin 11 (CTCSS out) of the DB-25 line I/O connector.  
See “IP-223 CTCSS Out Setup” on page 7.

Second method:

- Pin 13 and pin 25 (TX out) on the DB-25.  
See “IP-223 TX Out Setup” on page 7.

### 6.1 IP-223 CTCSS Out Setup

Using CTCSS pin 11 provides both RX and TX audio summed into a single output. The summed level is adjustable using the appropriate CTCSS line out hardware adjustment.

**NOTE:** Pin 11 is a single-ended capacitive blocked 600 Ohm output.

#### 6.1.1 IP-223 CTCSS Pin Setup.

**NOTE:** Optional Telex pre manufactured radio cables do not have pin 11 extending outside the DB-25 connector cover and must be modified in the field by adding a wire.

Local mode operation:

- Pin 11 is a selectable feature.

All other modes of operation:

- Summed audio is hardcoded to be on.

#### 6.1.2 IP-223 CTCSS Software Setup

1. Open **TSM**.
2. In the Processed Devices Pane, select the **IP-223** to configure.
3. Click the **Per Line Setup** tab.  
*The Per Line Setup page appears.*
4. Click **configure** for the line to configure.  
*The Per Line notebook appears.*
5. Click the **Options** tab.  
*The Options page appears.*
6. From the CTSS setup group box, select the **Tape Output** radio button.

### 6.2 IP-223 TX Out Setup

Using pins 13 and 25 provides both RX and TX audio output summed into a single balanced transformer coupled 600 ohm pair. Equipment layout and recorder input requirements sometimes require the use of additional IP-223's feeding the recorder. Radios or dispatch consoles located away from the recorder inputs or the recorder only accepting balanced audio pairs requires this method of connection.

The level is adjustable using the appropriate line out TX hardware adjustment.

## 6.2.1 IP-223 Line TX Recorder Output Setup

To **configure the IP-223's mode of operation**, do the following:

1. While in TSM, select the **IP-223 to configure** from the Processed Devices pane.
2. Click the **Per Line Setup** tab.  
*The Per Line Setup page appears.*
3. Select the **Local** check box for the IP-223 to configure.
4. Configure the **IP-223 jumpers for 4-wire operation**.

**REFERENCE:** For jumper settings, see the IP-223 Technical Manual (P/N 803641).  
This document is available for download at [www.telex.com/Downloads/](http://www.telex.com/Downloads/).

## 6.2.2 IP-223 Multicast Address Setup

Two (2) examples of IP-223 multicast setup are given below.

First method

- uses an IP-223 with radios.

Second method

- uses an IP-223 with C-Soft configured with positional recording.

### 6.2.2.1 IP-223 Multicast Setup With Radios Example

In this example, lines 1 and 2 are feeding the recorder from a system of remote IP-223s with radios attached.

To **configure multicast**, do the following:

1. While in TSM, click the **Multicast** tab.  
*The Multicast page appears.*
2. In the TX Port field for line 1, enter **1072**.
3. In the TX Group Port field for line 1, enter **1054**.
4. In the RX Port field, enter a **port number**.

**NOTE:** The RX port number must be unique from all port numbers used in the system.

5. In the TX Port field for line 2, enter **1073**.
6. In the TX Group Port field for line 2, enter **1055**.
7. In the RX Port field, enter a **port number**.



**NOTE:** The RX port number must be unique from all port numbers used in the system.

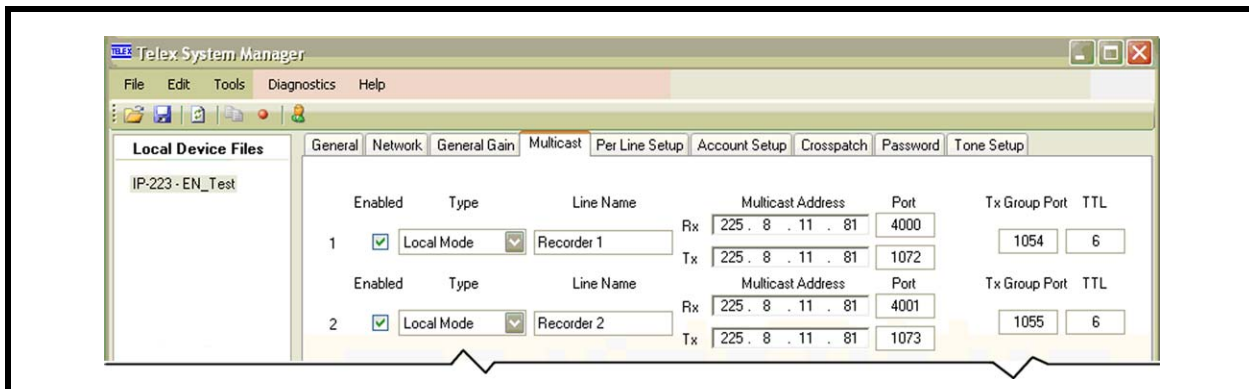

FIGURE 5. IP-223 With Radios—Multicast

### 6.2.2.2 IP-223 Multicast Setup with C-Soft Positional Recording Example

In the next example, line 1 and line 2 are feeding the recorder from an remote C-Soft console with positional recording turned on. Additionally, recording parameters must be configured.

To **configure the line for C-Soft positional recording**, do the following:

1. While in TSM, click the **Multicast** tab.  
*The Multicast page appears.*
2. In the TX Port field for line, enter **2000**.
3. In the TX Group Port field for line 1, enter **2001**.
4. In the RX Port field, enter a **port number**.

**NOTE:** The RX port number must be unique from all port numbers used in the system.

5. In the RX Port field for line 2, enter **2002**.
6. In the RX Group Port field for line 2, enter **2003**.
7. In the TX Port field, enter a **port number**.

**NOTE:** The RX port number must be unique from all port numbers used in the system.

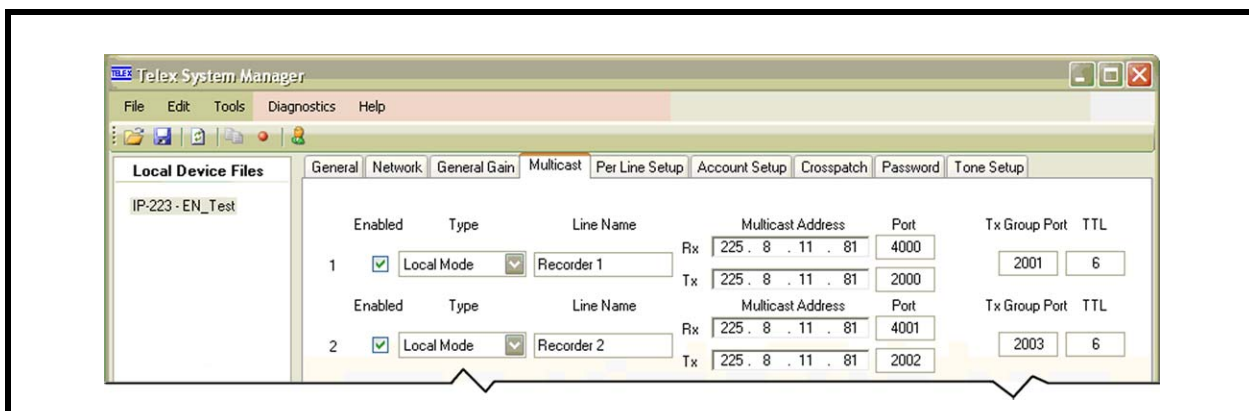

FIGURE 6. IP-223 Multicast Setup with C-Soft

### 6.2.2.3 *Positional Recording Setup*

Once the IP-223 is configured, C-Soft must be setup for positional recording using Global Parameters Setup. After the configuration is complete, the recorder feeds both Select speaker and microphone audio streams from this console

To **configure the recording parameters**, do the following:

1. Open **C-Soft Designer**.
2. From the menu bar, select **File|Setup Global Parameters**.
3. From the Select Speaker Output group box, enter the following:
  - Select the **Enable** check box.
  - From the Vocoder Type drop down menu, select **ADPCM 32K**.
  - In the Multicast field enter the same **Multicast Address** used for the IP-223.
  - Enter the **same port number** as the TX Group Port number configured on the IP-223.
4. From the Mic Output group box, enter the following:
  - Select the **Enable** check box.
  - From the Vocoder Type drop down menu, select **ADPCM 32K**.
  - In the Multicast field enter the same **Multicast Address** used for the IP-223.
  - Enter the **same port number** as the TX Group Port number configured on the IP-223.

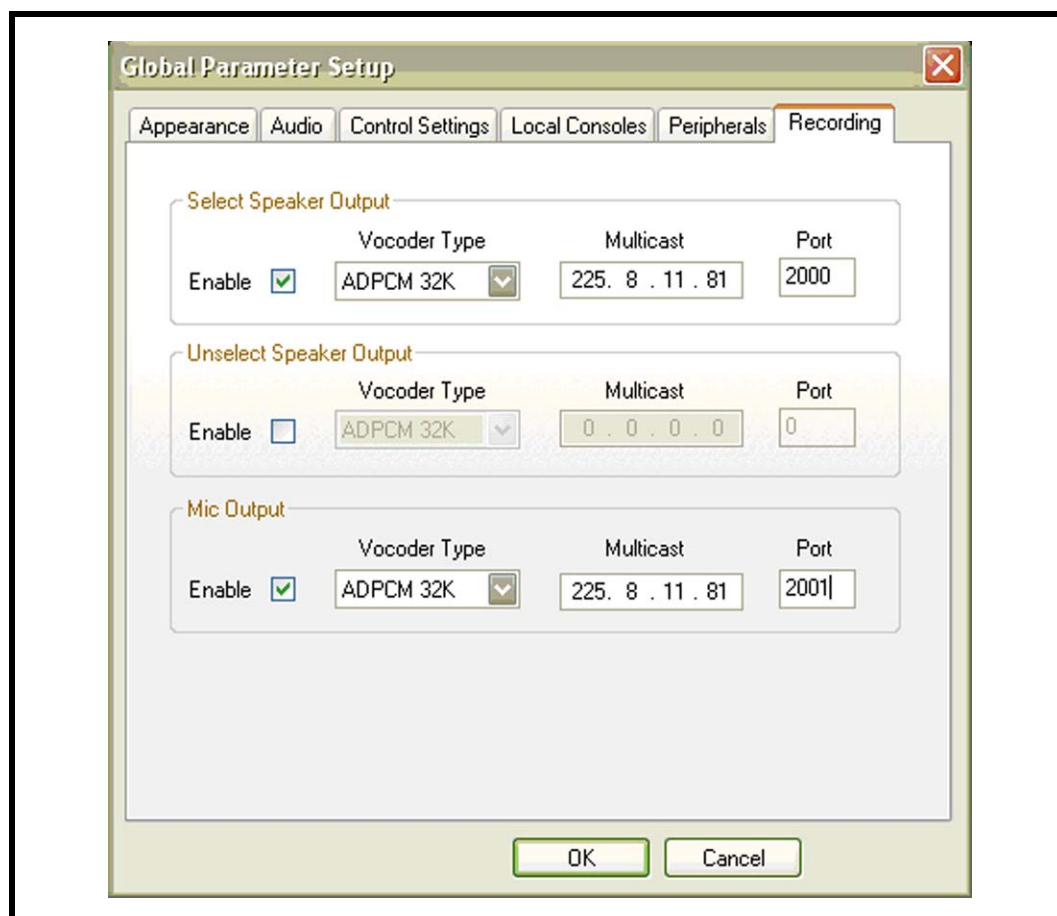

FIGURE 7. Recording Page—Global Parameters

<b>Revision History</b>		
<b>Document Title:</b> Connecting Telex VoIP Dispatch Systems to Analog Recorder Solutions		
<b>Document Number:</b> AN-DISPATCH-042		
<b>Revision</b>	<b>Change Description</b>	<b>Date</b>
A	Initial Release	30-APR-2009
B	Update brand, format and new document number.	15-NOV-2009

**Suggestions or comments:**

Contact technical support with suggestions or comments concerning this application note.

**Technical Support:**

**Email:** TelexDispatchtechsupport@us.bosch.com

**Fax:** 1-402-467-3279

**Phone:** 1-800-898-6723

Bosch Security Systems, Inc.  
8601 East Cornhusker Highway  
Lincoln Nebraska 68507

**Phone: (800) 752-7560 Fax: (402) 467-3279**

**Email: [Telexdispatch@us.bosch.com](mailto:Telexdispatch@us.bosch.com)**

**Web: [www.telex.com](http://www.telex.com)**

**Downloads: [www.telex.com/Downloads/](http://www.telex.com/Downloads/)**