



**BOSCH**

# **RADION receiver SD**

B810



**en**

Reference Guide



## Table of contents

<b>1</b>	<b>Introduction</b>	<b>5</b>
1.1	About documentation	5
1.2	Bosch Security Systems B.V. product manufacturing dates	5
<b>2</b>	<b>General installation</b>	<b>6</b>
2.1	Installation workflow	6
2.2	Unpacking information	7
2.3	Wall tamper switch installation	7
2.4	Magnet cover installation	7
2.5	Complete installation	7
2.6	Maintenance	8
<b>3</b>	<b>RADION receiver SD</b>	<b>9</b>
3.1	Check-in interval and power level for RADION devices	9
3.2	Certifications and approvals	9
3.3	UL product requirements	12
3.4	Installation	15
3.4.1	Configuration	15
3.4.2	Base installation	16
3.4.3	Wiring considerations	16
3.4.4	Programming wireless points in the control panel	17
3.4.5	Enroll point RF ID for wireless points (Auto-learn mode)	19
3.4.6	Walk test (for motion detectors)	19
3.4.7	Signal level and margin	20
3.4.8	Complete the installation	21
3.4.9	B810 system test	21
3.5	External LED states	21
3.5.1	LEDs	22
3.6	Specifications	23
3.6.1	Battery requirements	23
<b>4</b>	<b>RADION repeater</b>	<b>26</b>
4.1	RFRP2	26
4.1.1	Installation considerations	26
4.1.2	Wiring considerations	27
4.1.3	Specifications	27
4.1.4	LEDs	27
4.2	RFRP	28
4.2.1	Installation considerations	28
4.2.2	Wiring considerations	29
4.2.3	Specifications	29
4.2.4	LEDs	29
<b>5</b>	<b>RADION glassbreak</b>	<b>31</b>
5.1	Installation considerations	31
5.2	Testing	32
5.3	Low battery	33
5.4	Wall Tamper Tab	34
5.5	Maintenance	34
<b>6</b>	<b>RADION TriTech</b>	<b>35</b>
6.1	Mounting height and range adjustment	35
6.2	Sensitivity settings	36

6.3	Walk testing	36
7	<b>RADION PIR</b>	<b>38</b>
7.1	Walk testing	38
8	<b>RADION PIR C</b>	<b>40</b>
8.1	Walk testing	40
9	<b>RADION smoke RFSM2</b>	<b>42</b>
10	<b>RADION CO</b>	<b>43</b>
11	<b>RADION heat</b>	<b>44</b>
12	<b>RADION smoke</b>	<b>45</b>
12.1	Battery replacement	46
12.2	Smoke test	46
12.3	Sensitivity test	46
12.4	Test/Silence button	47
12.5	LED	47
12.6	Clean the detector and replace the optical chamber	47
13	<b>RADION contact SM</b>	<b>49</b>
13.1	Installation considerations	49
14	<b>RADION contact RM</b>	<b>51</b>
14.1	Installation considerations	51
15	<b>RADION specialty</b>	<b>53</b>
15.1	Applications for this product	54
15.2	Installation consideration	54
16	<b>RADION universal transmitter</b>	<b>55</b>
16.1	Installation considerations	56
16.2	Reed switch settings	57
17	<b>RADION keyfob</b>	<b>58</b>
17.1	RADION keyfob FB	59
17.2	RADION keyfob TB	60
18	<b>RADION panic FP</b>	<b>61</b>
19	<b>Appendices</b>	<b>62</b>

# 1 Introduction

This document contains the basic information that a trained installer needs to install the RADION system. It supplements the documents listed inside the packaging (graphical installation guides).

This reference guide contains:

- A description of the general installation procedure.
- Device-specific installation procedures.
- Specification information.

## How to use this document

The information contained in this document is constructed in a manner that is systematic and sequential for the installer on a “point of need” basis. The following represents a basic outline of that information;

- Chapter 1 (this chapter) – introductory information and how to use this document.
- Chapter 2 – basic RADION system-wide general installation information and workflow check list.
- Chapter 3 – RADION receiver-specific installation information.
- Remaining chapters – RADION device-specific installation information.
- Appendix – description of various icons and symbols used within the RADION documentation.

## Icons and symbols

When you see the following logo in the RADION graphical installation guides listed in Table 3.1, refer to the appropriate section in this document.



Additional icons and symbols, which appear in the RADION graphical installation guides, are explained in the appendix section of this guide. Refer to the *Appendices, page 62* for more information.

## 1.1 About documentation

### Copyright

This document is the intellectual property of Bosch Security Systems B.V. and is protected by copyright. All rights reserved.

### Trademarks

All hardware and software product names used in this document are likely to be registered trademarks and must be treated accordingly.

## 1.2 Bosch Security Systems B.V. product manufacturing dates

### Manufacturing dates

For product manufacturing dates, go to <http://www.boschsecurity.com/datecodes/> and refer to the serial number located on the product label.

## 2 General installation

### Phases of installation

The installation of the RADION system is achieved by following the sequential process as defined in this chapter. Overall, there are four main phases;

- Planning
- Physical installation of the devices
- System enrollment/configuration
- System testing (walk test, pattern test)

It is essential that these steps or phases are adhered to in the order mentioned above for proper functionality and operation.

When installing a RADION system, you must plan your installation based on the control panel and RADION device specifications, and the radio-frequency signal strength (RFSS) between devices, receivers, and control panels.

### Installation considerations

- RADION devices are intended only for indoor, dry applications.
- Mount RADION devices on flat, rigid surfaces. Some devices can be optionally corner mounted as indicated in the installation instructions.
- Avoid mounting RADION devices in areas with large, metallic objects, electrical panels, or electric motors. They might reduce the radio-frequency (RF) range of a RADION device.
- Avoid installing the devices where excessive humidity, moisture, or temperatures outside of the acceptable operating range exist.
- Wire all objects according to their specifications.
- RADION devices use batteries of varying types. When installing batteries, observe safety and polarity recommendations as indicated in the documentation for those products.

### 2.1 Installation workflow

To install, configure, and test the system, use the workflow below and follow in sequential order, from top to bottom, checking each box as you complete a step.



#### Notice!

Always power down the control panel when connecting modules, or other wiring. Power down the control panel by unplugging the transformer and disconnecting the battery

- Plan the installation of the RADION system
- Install the RADION components (refer to the graphical installation guides and this system reference guide for details)
- Program wireless points in the control panel
- Enroll point RF ID for wireless points
- Verify LED responses on devices
- Perform a local walk test for installed detectors
- Review signal strength and margin of each point
- Complete the installation

## 2.2 Unpacking information

When unpacking the receiver, repeater, or bill trap device, it is important to remove the cardboard insert as illustrated below;

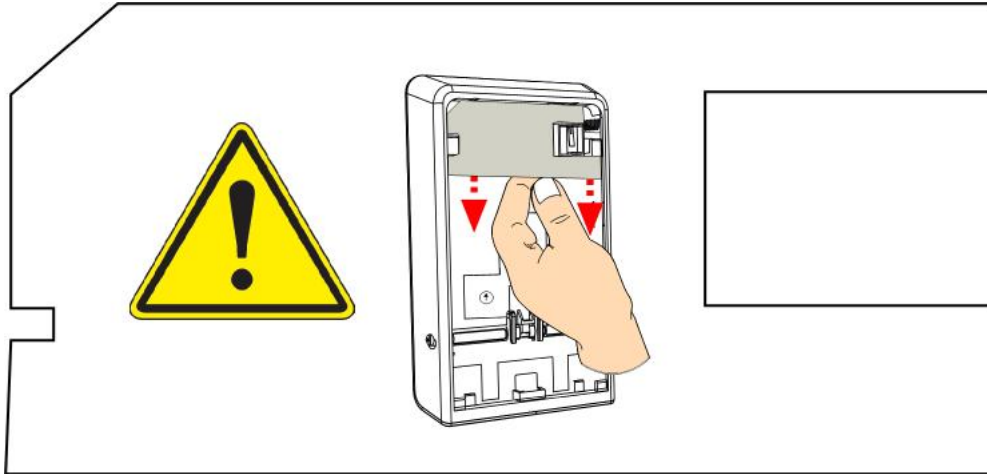

Figure 2.1: Insert for the receiver and repeater

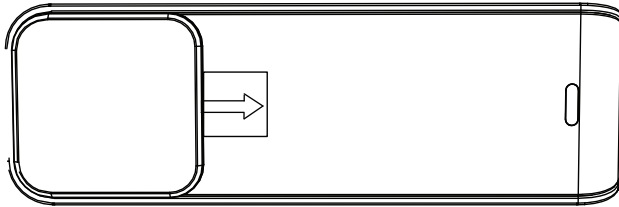

Figure 2.2: Insert for the bill trap

## 2.3 Wall tamper switch installation

RADION transmitter devices contain a feature that activates the wall tamper switch located on the base of the device. In order to properly install the device, you must consider the following:

- To properly install a device with active wall tamper functionality, insert a screw in the designated screw slot location.
- Failure to insert a screw into the wall tamper slot prevents the wall tamper feature from generating a tamper signal when the transmitter is pulled away from a wall.

## 2.4 Magnet cover installation

During the installation of the plastic magnet cover, the cover is not designed to be separated from the base after the base and cover are snapped together. Damage to the plastics may occur if separated.

## 2.5 Complete installation

Testing the entire RADION system can only be achieved by performing an area wide test through the control panel and corresponding keypad(s). This is achieved by performing an overall service walk test. Refer to your control panel documentation for system-walk, or other system-wide testing procedures.

To ensure proper operation of the RADION devices, test the basic functionality of the device locally. Depending on the RADION device to be tested, perform the following procedures for functionality:

- When testing the receiver, power up the compatible control panel in which the receiver is connected to and observe the LED behavior on the receiver.
- Local walk testing can be performed on the motion detectors as defined in the tritech and PIR chapters of this guide.
- Magnet testing can be performed by opening or closing the door/window in which the magnet is installed on.

## 2.6 Maintenance

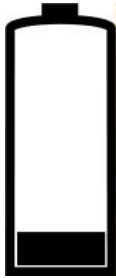

It is recommended to check the battery of each device annually. This will ensure proper operation and functionality of the devices.

### **Battery Life Extension feature (PIR and TriTech)**

In the normal operating mode, an alarm can be transmitted only after three (3) minutes have passed since the previous alarm restoral. This 3 minute lockout time reduces unnecessary RF transmissions in high traffic areas, thereby extending battery life.



### 3 RADION receiver SD

The receiver connects RADION wireless peripherals to supported Bosch control panels using the SDI2 bus connection. A compatible control panel powers the receiver through the wiring connection. Features include:

- Easy addressing via a rotary switch
- Cover and wall tamper protection
- RFID and configuration data are contained in persistent memory
- External LED
- Detection and reporting radio frequency interference
- Supports supervision of wireless points (504), keyfobs (1000), and repeaters (8)

#### 3.1 Check-in interval and power level for RADION devices

The RADION suite of devices come in three varieties and are compatible with three RADION receivers. The three varieties are: -A versions (ex. RFRP -A), Non -A versions (ex. RFRP), or CHI versions (ex. RFRP-CHI).

Each variety of detector was originally designed for a certain geographical region, and catered to that specific region's regulatory requirements. The B810 receiver supports all device versions. The slight differences are described below:

- -A version. The -A version is called the "American" version and complies with applicable regulatory requirements, and is used in North and South America. -A devices are sold in North and South America. The supervision message is 3 dB lower than the alarm message, and the supervision interval is (approx.) every 65 minutes.
- Non -A version. The Non -A version is the European version and complies with applicable regulatory requirements in Europe. Non -A devices are sold in Europe, Africa, and Australia. The supervision and alarm messages operate at the same power level and the check-in interval is 13 minutes.
- CHI version. The CHI version is the Chinese version and complies with applicable regulatory requirements in China. CHI devices are sold exclusively in China. The supervision and alarm messages operate at the same power level and the check-in interval is 13 minutes.

The following table shows check-in intervals and power levels for all RADION devices within the B810 wireless receiver security system.

**Check-in differences between -A and non -A RADION devices**

Item	-A version	Non -A/CHI version	Devices affected
Check-in interval	65 minutes	13 minutes	All RADION devices
Power level for check-in messages	3 db less than alarm message	Same as alarm message	All RADION devices

**Tab. 3.1: Check-in differences**

#### 3.2 Certifications and approvals

##### Listings and approvals

##### UL

The B810 is UL listed for Commercial/Residential Burglar Alarm Systems, and Household Fire Warning System Units.

**Products evaluated by UL**

The following products have been evaluated by UL:

- B810 wireless receiver
- RFRP-A repeater
- RFRP2 repeater
- RFBT-A specialty (billtrap)
- RFDW-SM-A standard door/window contact
- RFDW-RM-A recessed door/window contact
- RFDL-11-A motion detector
- RFPR-12-A PIR motion detector
- RFPR-C12-A PIR motion detector (curtain)
- RFUN-A universal transmitter
- RFSM-A smoke detector
- RFSM2-A smoke detector
- RFHT-A heat detector
- RFCO-A CO detector
- RFKF-TB-A keyfob
- RFKF-FB-A keyfob
- RFPB-TB-A panic
- RFPB-SB-A panic
- RFPB-FP-A fixed position panic
- RFKF-FBS-A keyfob
- RFKF-TBS-A keyfob

**Products not evaluated by UL**

The following products have not been evaluated by UL:

- RFGB-A/RFGB/RFGB-CHI glassbreak
- RFRP2-CHI repeater
- RFRP/RFRP-CHI repeater
- RFBT/RFBT-CHI specialty (billtrap)
- RFDW-SM/RFDW-SM-CHI standard door/window contact
- RRDW-RM/RFDW-RM-CHI recessed door/window contact
- RFDL-11/RFDL-11-CHI motion detector
- RFPR-12/RFPR-12-CHI motion detector
- RFPR-C12/RFPR-C12-CHI motion detector (curtain)
- RFUN/RFUN-CHI universal transmitter
- RFSM/RFSM-CHI smoke detector
- RFKF-FB/RFKF-FB-CHI keyfob
- RFKF-TB/RFKF-TB-CHI keyfob
- RFKF-FBS/RFKF-FBS-CHI keyfob
- RFKF-TBS/RFKF-TBS-CHI keyfob
- RFPB-TB/RFPB-TB-CHI panic
- RFPB-SB/RFPB-SB-CHI panic

**UL battery requirements**

UL recommends to check the battery of each device annually. This will ensure proper operation and functionality of the devices.

**Notice!**

RFRP2 battery

The battery for the RFRP2 is not user replaceable.

For the RFBT-A bill trap, UL requires the battery to be replaced annually to ensure optimal performance.

**Battery testing**

To ensure proper functionality of each RADION device, it is recommended to test your batteries annually via your supported control panels wireless diagnostics routine. For specific information related to system diagnostics and battery testing, refer to your supported control panel documentation.

**Federal Communications Commission (FCC) Rules**

This device complies with part 15 of the FCC Rules. Operation is subject to the following two conditions: (1) This device may not cause harmful interference, and (2) this device must accept any interference received, including interference that may cause undesired operation. This equipment has been tested and found to comply with the limits for a Class B digital device, pursuant to Part 15 of the FCC rules. These limits are designed to provide reasonable protection against harmful interference in a residential installation. This equipment generates, uses, and can radiate radio frequency energy and, if not installed and used in accordance with the instructions, may cause harmful interference to radio communications. However, there is no guarantee that interference will not occur in a particular installation. If this equipment does cause harmful interference to radio or television reception, which can be determined by turning the equipment off and on, the user is encouraged to try to correct the interference by one or more of the following:

- Reorient or relocate the receiving antenna.
- Increase the separation between the equipment and receiver.
- Connect the equipment into an outlet on a circuit different from that to which the receiver is connected.
- Consult the dealer or an experienced radio/TV technician for help.

**INDUSTRY CANADA (IC) Rules**

This device complies with Industry Canada licence-exempt RSS standard(s). Operation is subject to the following two conditions: (1) this device may not cause interference, and (2) this device must accept any interference, including interference that may cause undesired operation of the device.

Le présent appareil est conforme aux CNR d'Industrie Canada applicables aux appareils radio exempts de licence. L'exploitation est autorisée aux deux conditions suivantes : (1) l'appareil ne doit pas produire de brouillage, et (2) l'utilisateur de l'appareil doit accepter tout brouillage radioélectrique subi, même si le brouillage est susceptible d'en compromettre le fonctionnement.

Under Industry Canada regulations, this radio transmitter may only operate using an antenna of a type and maximum (or lesser) gain approved for the transmitter by Industry Canada. To reduce potential radio interference to other users, the antenna type and its gain should be so chosen that the equivalent isotropically radiated power (e.i.r.p.) is not more than that necessary for successful communication.

Conformément à la réglementation d'Industrie Canada, le présent émetteur radio peut fonctionner avec une antenne d'un type et d'un gain maximal (ou inférieur) approuvé pour l'émetteur par Industrie Canada.

Dans le but de réduire les risques de brouillage radioélectrique à l'intention des autres utilisateurs, il faut choisir le type d'antenne et son gain de sorte que la puissance isotrope rayonnée équivalente (p.i.r.e.) ne dépasse pas l'intensité nécessaire à l'établissement d'une communication satisfaisante.

**CE**



**RCM**



This device is RCM marked and complies with applicable Australian requirements.

### 3.3 UL product requirements



**Notice!**

For all wireless devices, receivers, and/or repeaters, do not install on removable surfaces such as ceiling tiles.

For product-specific UL requirements, refer to desired product title below for more information.

**RADION Repeater (RFRP2)**



**Notice!**

Globtek power supply  
The Globtek power supply is not evaluated by UL.



**Notice!**

UL system compliance  
For UL system compliance the RFRP2 shall be connected to a UL Listed Residential Fire/UL Residential Burg/ Commercial Burglar Alarm power supply with a class 2 power limited output with a voltage range of 10-14VDC , (nominal)1 Amp @12VDC Max.

**Compatible power supply**

Compatible plug-in transformers for use with the RFRP2 repeater include:

- WR9QE1000A00N6WG3150 - 12V, 1A power supply with NAM blade. (S/N: F.01U.398.526)

For installations installations other than the U.S., transformers must meet the country-specific requirements.

**Compatible blade kit**

- Q-KIT-INTL-6-WH-RB - International blades for 12V, 1A. (S/N: F.01U.398.527)

**Power/voltage**

12 VDC, 1 A

**RADION Repeater**

When selecting a suitable 16.5 VAC Class 2 plug in transformer, the following transformers are suggested:

- MG Electronics (MGT-1640)

- Codex SEP-1640

The transformers mentioned above are Primary Rated 120 VAC, 60 Hz, 0.48 Amps, Secondary 16.5 VAC, 40 VA.

When selecting a suitable 18 VAC Class 2 plug-in transformer, the following transformers are suggested:

- TDC Part No DA-22-18, Primary Rated 120 VAC, 60 Hz, 30 VA, Secondary Rated 18 VAC, 1.22 Amps, 22 VA.

**Notice!**

For UL installations when transformer is used, restraining tab is to be connected.

---

**Notice!**

For UL installations when a repeater is installed, a minimum of two repeaters must be installed for proper signal routing.

---

Information related to the internal standby battery is as follows:

- Power/voltage (Standby Battery): Rated 3.7 VDC, 3050mAh, EVE ENERGY CO Part No P0046-LF (Not user replaceable)
- 

**Notice!**

For standby battery to be operative, the tamper switch is required to be engaged.

---

Standby battery is capable of providing 72 hours of standby power to the RF repeater for a UL Burglar Alarm Installation (Bank Safe and Vault).

- 24 Hours for Household Fire Warning Systems
- 8 Hours for HOLD UP Burglar Alarms
- 4 Hours for Burglar Alarm Mercantile Installations

**RADION glassbreak**

---

**Notice!**

The RFGB-A has not been investigated by UL, and not part of a UL Listed system.

---

**RADION TriTech**

---

**Notice!**

Pet Immunity has not been evaluated by UL.

---

**Notice!**

Draft and Insect Immunity has not been evaluated by UL.

---

**RADION smoke**

For UL installations THIS UNIT INCLUDES AN ALARM VERIFICATION FEATURE THAT WILL RESULT IN A DELAY OF THE SYSTEM ALARM SIGNAL FROM THE INDICATED CIRCUITS. THE TOTAL DELAY (CONTROL UNIT PLUS SMOKE DETECTORS) SHALL NOT EXCEED 60 SECONDS. NO OTHER SMOKE DETECTOR SHALL BE CONNECTED TO THESE CIRCUITS UNLESS APPROVED BY THE LOCAL AUTHORITY HAVING JURISDICTION.

**RADION contact SM**

During the installation of the device, UL installations primary securement means shall be screws.

**RADION contact RM**

During the installation of the device, UL installations primary securement means shall be screws.

**RADION specialty**

When programming the bill trap, special programming for a hold up device is required.

Program the point as follows:

- P## Type = 2 (Point is constantly armed regardless of the status of the system).
- ☐P## Invisible Point = Yes (Keypads do not display alarm activity from this point).

For UL installations, the RFBT-A shall be permanently mounted using the 3M VHB 4956 double sided adhesive tape. The suitable surfaces are:

- Aluminum
- Galvanized steel
- Stainless steel
- Enameled steel
- Nickel Coated ABS
- Glass (with or without Silane Coating)
- PVC
- Glass/Epoxy
- PBT
- Polycarbonate
- Acrylic/Polyurethane paint
- Polyester paint

**RADION universal transmitter**

During the installation of the device, the following items are required by UL:

- For UL installations, an UL Listed burglar alarm dry contact device shall be connected if the external terminal is used.
- When external contact is configured for UL hold up installations, a hold up device such as potter electric model HUB is to be connected to the external contact. For programming, refer to the appropriate control panel manual "Special programming required for a hold up device." Point shall be programmed as stated below:
  - P## Type = 1 Instant on open or short (Point is constantly armed regardless of the status of the system).
  - ☐P## Invisible Point/Silent Bell = Yes (Keypads do not display alarm activity from this point).

Furthermore for UL hold up installations the internal reed switch is to be disabled. The door window contact magnet will not be operative. The transmitter if used for hold up installations shall be dedicated to a holdup installation only. Hold up alarm requires a UL Listed Automation System at the Central Station to show distinction between a Hold Up Alarm and a regular Burglar Alarm.

- For UL installations, a 2.2 K ohm shall be installed.
- For UL installations, primary securement means shall be screws.

#### **RADION keyfobs**

To comply with UL 1023, RADION keyfobs shall be programmed with Forced Arm Bypass Max set to 0.

## **3.4 Installation**

Use the anchors and screws to install the receiver in locations accessible for future maintenance. Install the receiver onto a wall.

For best performance, place the receiver in a central location among the transmitters. For optimal communication results in situations where there is a long distance between the transmitting device and the system receiver, it might be necessary to install repeaters.



#### **Notice!**

Install the receiver in a location away from metal objects. Metal objects (duct work, wire mesh screens, boxes) reduce RF range.

### **3.4.1 Configuration**

RADION Wireless System operates on a radio frequency of 433.42 MHz.

#### **Configuring the address switch**

This switch determines the receiver's numeric address value which the receiver will use to report receiver status information to the control panel. Set the address to the receiver prior to installation. Address 1 through 4 are valid address settings for the receiver. Use a slotted screwdriver to set the address switch.

#### **Address settings**

The receiver switches provide a single-digit setting for the receiver's address. Addresses 0 and 5 are invalid and will cause the receiver to enter into an SDI2 communication error state. This causes the receiver to be unrecognized by the control panel. The receiver uses Address 9 to reset itself when the keyfob becomes inoperable. Refer to the Notice below and procedure regarding the synchronization of the keyfob with the receiver.

Refer to your control panel documentation for information on the valid addresses for that control panel. The figure below shows the address switch setting for address 1.



**Figure 3.1:** Address switch set to 1

**Notice!**

Inoperable RADION keyfob

If the RADION keyfob no longer operates as originally programmed, try resetting the receiver. RF IDs remain active if previously enrolled, and will not have to be re-enrolled when resetting the receiver.

**Failure conditions**

The following conditions describe the state of the keyfob when it no longer arms/disarms the security system:

- The keyfob is correctly programmed in the control panel, and
- The receiver LED flashes when the keyfob is activated, but
- The expected action (arm/disarm) does not occur at the control panel.

**Synchronizing the keyfob with the receiver**

Perform the following steps to reset the receiver and restore arming/disarming functionality for the keyfob.

Resetting the receiver:

1. Power off the receiver (or remove the receiver from its base).
2. Set the receiver address switch to 9.
3. Power on the receiver (or re-attach the receiver to its base).
4. LED indicates the firmware version. The LED turns on steady for a short time to reset the receiver, and then turns off. Replace the receiver if the LED continues to flash.
5. Power off the receiver (or remove the receiver from its base).
6. Set the receiver address switch back to the original address setting.
7. Power on the receiver (or re-attach the receiver to its base).
8. Your system is ready for normal operation.

**3.4.2****Base installation**

Some consideration and planning are required when locating a position to install onto the desired surface. The base must be installed to provide plenty of accessible space to insert a flat-headed screwdriver, and remove the receiver cover for maintenance and troubleshooting. You will need approximately 254 mm (10 in) of clearance on one side of the base to provide easy access to the opening mechanism, and approximately 15 mm (0.6 in) of clearance on the opposite side to compensate for the physical dimensions of the device cover. This should allow for adequate space in which the device cover can be opened, and the cover removed.

Other mounting considerations include;

- Minimum clearance above the location to compensate for the vertical sliding movement to attach or remove the device from the base is: >30 mm (1.2 in).
- Minimum clearance below the location where the base is mounted: >23 mm (0.9 in).

**3.4.3****Wiring considerations****Notice!**

Do not install long cable runs next to high-current power feeds. Keep cable lengths as short as possible to minimize noise pickup.

Ensure that the wiring used meets the following specifications:

- Four-conductor unshielded 0.65 mm (22 AWG) to 2.0 mm (18 AWG) maximum.



- Wire length must not exceed 243 m (800 ft) from the control panel

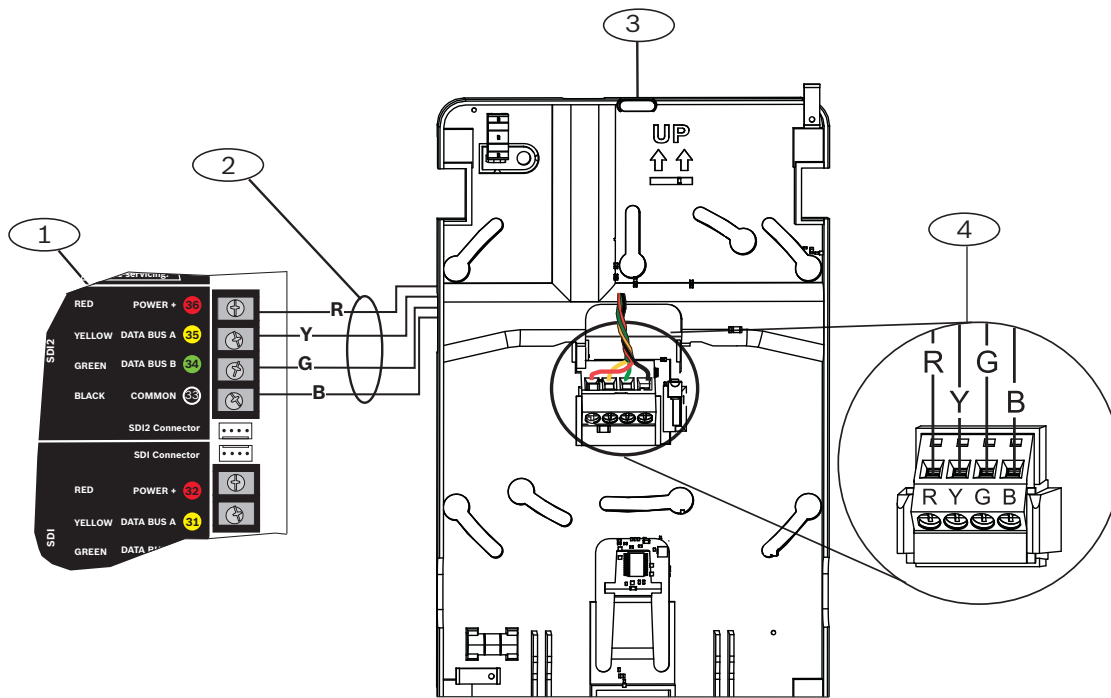

Figure 3.2: Wiring the receiver to an SDI2 compatible control panel

Callout	Description
1	SDI2 compatible control panel
2	Terminal wiring
3	RADION receiver SD mounting base
4	Module terminal block

### 3.4.4

#### Programming wireless points in the control panel

Configure the RADION points to establish communication between the RADION system and the control panel. This can be accomplished by using one of two methods:

- Using Remote Programming Software (RPS) on a supported laptop computer, or
- Compatible keypad devices to enable your points

A “point” can be a detection device, or a group of devices connected to your security system. The first step to enable communication is to verify that the RADION transmitter is programmed into the control panel. This is achieved by configuring a point source index as wireless.

RFID programming from a supported keypad is achieved by:

- Through the point source/RFID menu options, or
- Enroll point RFID for wireless points - which uses the “Auto-Learn” methodology.

The preferred method of entering in the RFID number would be to enter it manually through the keypad - point source/RFID, or RPS. Doing so gives you greater control and security, while reducing the risk of incomplete RFID programming.

The workflow listed below is a generic representation of the programming/enablement process. Refer to the Points Menu Parameters section inside the Keypad Installer Menu chapter of the compatible Bosch control panel Installation and System Reference Guides, or Points - Point Assignments in RPS Help File for more information.

### Point source/RFID programming

A point's source gives a description as to the physical location of the point for installation and service personnel:

1. Using either RPS, or a supported keypad, access the Program Menu, and select the **Points** menu option.
2. Select the **Source** menu.
3. Select the point source of the device you are programming.
4. Change the point source to the "wireless."
5. Save changes.
6. Select the **RFID** menu to edit the RFID of each RADION device.
7. Enter in the unique RFID as it appears on the RFID sticker in the illustration below. ID's beginning with a zero may not display in the keypad UI, or RPS
8. Save changes and exit the menu.

The control panel is enabled to receive wireless communication information from the RADION transmitter.

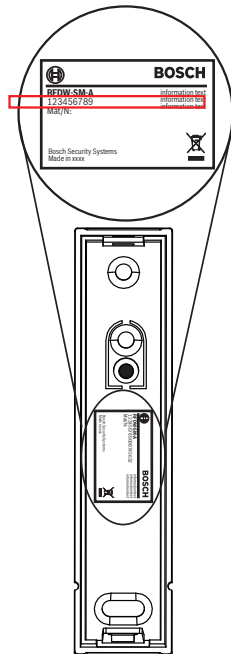

Figure 3.3: RFID sticker example

### Point indexes

Point indexes determine how points operate/respond to circumstances within a system:

1. Using either RPS, or a supported keypad, access the **Program Menu**, and select the **Points** menu.
2. Select the point source of the device you are programming and select the wireless device type. Ensure that it matches that of the physical device you are enrolling.
3. Assign the attributes of the point index (how the device will respond to various circumstances).
4. Save changes and exit the menu.

### Signal strength test (for repeaters)

1. From the keypad, access the **Wireless Menu**, and select **Diagnostics**.
2. Select **RF Repeaters**.
3. Select **Signal** and choose the repeater. Various sub-categories display including:

- Signal Strength
  - Level
  - Margin
4. Exit the menu.

### 3.4.5

#### Enroll point RF ID for wireless points (Auto-learn mode)

A second option exists whereby new devices are discovered on the system. This option is referred to as the “Auto Learn Mode” option. Auto Learn Mode is the process through which the control panel identifies and enrolls new device RF ID’s that appear within the system. This is achieved by the following:

- Keyfobs - when the keyfob buttons are pressed, then released.
- Motion detectors - when the battery is inserted, or if coverage pattern is disturbed by someone walking through the coverage pattern field.



#### Notice!

The Auto Learn mode option is not recommended as the preferred method of entering in the RF ID’s due to the potential of the RADION system picking up the first available RF ID it detects. For optimal results, manually enter in the RF ID’s through the supported keypad, or via RPS.

#### Enrolling a wireless point RF ID

Using a supported keypad, enroll the RF ID through the Wireless menu option. Use the **Wireless** menu to add, replace, remove, and diagnose points and repeaters.

Perform the following to enroll in the RF ID:

1. From the keypad, access the **Wireless Menu**, and select the **Points** menu option. If adding a repeater, select the **Repeater** menu option.
2. Select the option for enrolling a point RFID.
3. When asked, select the point source you are enrolling).
4. Initiate activity for the desired device (walk through the coverage pattern if enrolling a motion detector, or press the button on the keyfob if enrolling a keyfob, open the door or window if enrolling a contact). By doing so, the control panel recognizes the first RFID it comes in contact with.
5. When the keypad or RPS shows Point Enrolled, exit out of the application.
6. Verify the RFID displayed on the keypad matches the RFID sticker that appears on the activated device.

### 3.4.6

#### Walk test (for motion detectors)

Use the following pattern testing procedure to test the detector range and functionality.



#### Notice!

Also see Control Panels (D9412GV4/D7412GV4) SIA CP-01 Quick Reference Guide P/N: F.01U.265.466, and/or (B6512/B5512/B4512) SIA CP-01 Quick Reference Guide P/N: F.01U.265.464).

#### Motion walk test

Remove and replace cover to activate a 90-sec Walk Test Mode. During this Test Mode, any activity in the sensor’s coverage pattern will cause a transmitted alarm and LED activation. Each alarm will also extend the Test Mode for an additional 90-sec. Walk Testing should be done across the coverage pattern. The edge of the coverage pattern is determined by the first flash of the LED. This may change slightly depending upon the sensitivity setting. Walk Test

the unit from both directions to determine the pattern boundaries. Although generally not required, if masking is desired, the lens diagram shows the appropriate areas to be masked. Use an opaque material (such as, electrical tape) to mask the desired areas.

#### **Final test**

While the detector is in the Walk Test Mode, turn on all heating and air conditioning sources which would normally be active during the protection period. Stand away from the sensor and outside the coverage pattern and watch for alarms. After setup and tests are completed, and there has been no activity in the sensor's coverage pattern for approximately 90-sec, the LED flashes to indicate that the Walk Test mode is ending.

#### **Maintenance**

At least once a year, a walk test should be performed to verify the range and coverage for proper operation.

#### **Magnet walk test**

Perform a magnet test to ensure proper functionality of the door and window contacts. Magnet testing can be performed by opening or closing the door/window in which the magnet is installed. In this test, you are verifying the distances of which the magnet engages and disengages the transmitter.

### **3.4.7**

#### **Signal level and margin**

The signal level and margin (ambient signal) of the RADION system is dependent on the receiver location and transmitters communicating with it. Installing the receiver in an environment that has a lot of radio transmitter communication or other exterior disturbances, may reduce the receiver signal strength and margin signal of the receiver.

Signal Level is a measure of how loud a RADION receiver is hearing a message from a RADION transmitter; this value is displayed as a percentage with a range of 0% - 99%.

Signal Margin is a measure of how well a RADION receiver is hearing a message from a RADION transmitter given the current ambient noise levels, or 'white noise' at the receiver.

This value is displayed as a percentage with a range of 0% - 99%.

The concept of signal margin can be related to two people conversing in a room; when the room is quiet they hear each other clearly and the "signal margin" would be very high. In a noisy room they would not be able to hear each other as clearly and the "signal margin" would be much lower. When the signal margin is low enough conversation is no longer possible.

The RADION receiver monitors the signal level of every system transmitter and report an interference trouble (sometimes called Jamming) if the signal margin of a transmitter is reduced to the point where communications might be lost.

To ensure reliable system communications, the signal level and margin of every transmitter, including repeaters, should be tested and verified to be reporting "good" at the time of installation and in the unlikely event of a interference trouble report.

#### **Signal strength test (for Points and Receiver)**

Use the following procedure to test the frequency strength and range of the RADION system.

1. From the keypad, access the **Wireless Menu**, and select **Diagnostics**.
2. Select **RF Points**.
3. Select **Signal** menu and choose the desired option. Various sub-categories display including:
  - Signal strength
  - Level
  - Margin
4. Exit the menu.

**Signal strength test (for Repeaters)**

1. From the keypad, access **Wireless Menu**, and select **Diagnostics**.
2. Select **RF Repeaters**.
3. Select the **Signal** menu and choose the repeater. Various sub-categories display including:
  - Signal strength
  - Level
  - Margin
4. Exit the menu.



**Notice!**

For UL installations, the signal shall be checked to display “good.”

**3.4.8 Complete the installation**

Depending on the results of testing the RADION system from a system-wide approach (walk test, signal strength and margin tests), make the appropriate modifications/adjustments to complete the install process.

**3.4.9 B810 system test**

**Overall system test**

It is recommended by UL to test the entire system at least once every year, including the B810 receiver by an installer to ensure proper functionality of the RADION system.

**3.5 External LED states**

The receiver utilizes the External LED to show various states of the receiver. These states fall into the following three categories:

- Normal State
- Communication Error State
- Trouble State
- Maintenance state
- Off state

**Normal state:**

The receiver enters a normal state when it has passed all power self-tests and has established a communication link with the control panel . The receiver remains in this state as long as the communication link is present, and no other issues are present that would prevent the receiver from operating in a normal condition.

LED condition	State description
On (Normal)	Indicates the receiver is functioning normally.
Continuous slow flash: 1 sec On, 1 sec Off	Indicates the receiver is being programmed with the zone and transmitter ID’s from the compatible control panel.
Turns Off momentarily	Indicates the receiver obtained a valid transmission from a RADION transmitter.
Flash 3 times	Indicates the receiver has obtained a new device ID while in “Learn Mode.”

**Communication error state:**

The receiver enters a communication error state when, during power up, it does not establish a link with the control panel, or has been in an idle state for more than 30 sec without communication. Another cause for a communication error state is an invalid address switch setting (0, or 9).

LED condition	State description
3-pulse flash: A 3-pulse signal, followed by a short delay at the end of the 3 <sup>rd</sup> pulse (Communication error)	Indicates the receiver has experienced a communication failure. This error could be a result of either: <ul style="list-style-type: none"> <li>– A communication failure between the control panel and receiver, or</li> <li>– An invalid address switch setting</li> </ul>

**Trouble state:**

The receiver enters a trouble state when an internal self-test detects a failure. Another cause for the receiver entering into a trouble state would be if the receiver detects radio frequency interference failure.

LED condition	State description
Continuous fast flash: A continuous pulse between On and Off states (Trouble state)	<ul style="list-style-type: none"> <li>– Indicates the receiver is in a trouble state, experiencing a radio frequency interference failure</li> <li>– A communication failure with internal hardware components within the receiver</li> </ul>

**Maintenance state**

The receiver enters a maintenance state when the address switch settings are set between switch 5 – switch 8.

LED condition	State description
Continuous Flash: A continuous pattern of short off time, followed by long on time.	Indicates the receiver is in Maintenance Mode.

**Off state**

Indicates there is a power failure to the receiver. Check the wire connections for proper wiring.

**3.5.1****LEDs**

The receiver utilizes an external LED indicator to status the operation of the receiver. Refer to the table below for LED descriptions.

LED condition	Pattern description
On (Normal)	Indicates the receiver is functioning normally.
Off	Indicates there is a power failure to the receiver, or that the receiver is not wired correctly.

LED condition	Pattern description
Continuous Flash: 1 sec On, 1 sec Off	Indicates the receiver is being programmed with the zone and transmitter ID's from the compatible control panel.
Turns Off momentarily	Indicates the receiver obtained a valid transmission from a RADION transmitter.
Continuous Flash: A 3-pulse signal, followed by a short delay at the end of the 3 <sup>rd</sup> pulse (Communication error)	Indicates the receiver has experienced a communication error and/or a self-test failure. This error could be a result of either: <ul style="list-style-type: none"> <li>- A communication failure between the control panel and receiver, or</li> <li>- An invalid address switch setting.</li> </ul>
Continuous Flash: A continuous pulse between On and Off states (Trouble state)	<ul style="list-style-type: none"> <li>- Indicates the receiver is in a trouble state, experiencing a radio frequency interference failure.</li> <li>- A communication failure with internal hardware components within the receiver</li> </ul>
Flash 3 times:	Indicates the receiver has obtained a new radio frequency ID while in "Learn Mode".

### 3.6

### Specifications

Housing dimensions (H x L x D)	209.60 mm x 139.70 mm x 31.80 mm (8.25 in x 5.50 in x 1.25 in)
Power/voltage	10 -14 VDC, 12 VDC nominal
Maximum current draw	70 mA
Device testing	To ensure proper functionality, the device must be tested at least once every year by an installer.
Operating environment	0° C to +49° C (+32° F to +120° F)
Relative humidity	Up to 93% non-condensing
Frequency	433.42 MHz
Wiring distance	Maximum distance of 243 m (800 ft) from the control panel
Wiring gauge	0.65 mm (22 AWG) to 2.0 mm (18 AWG) maximum
Wall and cover tamper switch	Transmits a tamper signal when someone removes the device from its base or pulls it away from the wall.

**Tab. 3.2: Specifications**

#### 3.6.1

#### Battery requirements

Use sealed lithium or alkaline batteries for supported RADION wireless system peripherals. Replace the batteries annually to ensure optimal performance.



**Notice!**

Dispose of used batteries according to manufacturer’s instructions.



**Warning!**

The batteries used in the RADION transmitters might present a risk of fire or chemical burn if mistreated. Do not recharge, disassemble, heat above 100° C (212° F), or incinerate. Replace battery with battery manufacturer’s name or end product manufacturer’s name and part number only. Use of another battery might present a risk of fire or explosion.

**Battery requirements**

RADION Device	Battery Size	Battery Type	Cell Voltage	Quantity (Cells)
B810 receiver	None			
RADION PIR motion detector	CR123A	Lithium	3 VDC	1
RADION PIR C motion detector	CR123A	Lithium	3 VDC	1
RADION repeater	Non-replaceable	Lithium polymer	3.7 VDC nominal	1
RADION repeater (RFRP2)	Non-replaceable	Lithium	3.6 VDC	1
RADION smoke detector	CR123A	Lithium	3 VDC	2
RADION universal transmitter	CR123A	Lithium	3 VDC	1
RADION specialty bill trap	AAA	Lithium	1.5 VDC	1
RADION TriTech motion detector	AA	Alkaline	1.5 VDC	4
RADION contact RM recessed door/window contact	AAA	Lithium	1.5 VDC	1
RADION contact SM standard door/window contact	AAA	Lithium	1.5 VDC	1
RADION glassbreak detector	CR123A	Lithium	3 VDC	1
RADION keyfob FB key fobs	CR2032 (coin cell)	Lithium	3 VDC	1
RADION keyfob TB key fobs	CR2032 (coin cell)	Lithium	3 VDC	1



<b>RADION Device</b>	<b>Battery Size</b>	<b>Battery Type</b>	<b>Cell Voltage</b>	<b>Quantity (Cells)</b>
RADION panic TB/ RADION panic SB panic buttons	CR2032 (coin cell)	Lithium	3 VDC	1
RADION panic FP panic button	CR123A	Lithium	3 VDC	1
RADION Smoke and Heat	CR123A	Lithium	3 VDC	2
RADION Heat	CR123A	Lithium	3 VDC	2
RADION CO	AAA	Alkaline	1.5 VDC	2

**Tab. 3.3: Battery requirements**

## 4 RADION repeater

The RADION repeater is a wireless repeater device that re-transmits messages received from system detectors, for the purpose of improving the overall communication reliability of the wireless system. This is achieved by providing a secondary communication path for system detectors. Repeaters might be used to extend the range of a detector that must be installed beyond its maximum communication range.

An LED on the front provides device status.

Features include:

- LED Display
- Cover and Wall Tamper protection

### **RADION repeater compatibility**

The RADION wireless security system supports two RADION repeater models:

- RFRP-A
- RFRP2



#### **Notice!**

Use a supported transformer as defined in the specification table for the repeater. Do not connect power supply to a receptacle controlled by a switch.

---



#### **Notice!**

When used in a life safety application (such as in a fire warning system) at least two repeaters must be used to provide redundant communication paths. Perform the Redundant Verification Process.

---

### 4.1 RFRP2

#### **Redundant Communication verification process**



#### **Notice!**

If this is a new install, keep the plastic battery tab in the current position, perform the verification process, and then remove the plastic tab. If the repeater has already been installed, and the plastic tab removed, re-insert the plastic tab into the battery terminal before performing the verification process.

---

1. Build a network of repeaters.
2. Remove DC and battery power from one repeater.
3. Start all other repeaters by removing and reinserting the repeater back onto the mounting plate.
4. Make sure all repeaters have “good” signal strength as displayed in RPS or from the control panel keypad.
5. Re-apply the DC and battery power to the current repeater.
6. Repeat steps 2-5 until all repeaters in your environment have gone through the verification process and a redundant communication path is confirmed.
7. Make sure all other devices operate and report correctly, and have good signal strength.

#### 4.1.1 Installation considerations

Use the provided anchors and screws to mount the repeater in locations accessible for future maintenance. Mount the repeater onto a wall.



**Notice!**

Mount the repeater in a location away from metal objects. Metal objects (duct work, wire mesh screens, boxes) reduce RF range

**4.1.2 Wiring considerations**



**Notice!**

Do not install long cable runs next to high-current power feeds. Keep cable lengths as short as possible to minimize noise pickup.

**4.1.3 Specifications**



**Notice!**

UL system compliance

For UL system compliance the RFRP2 shall be connected to a UL Listed Residential Fire/UL Residential Burg/ Commercial Burglar Alarm power supply with a class 2 power limited output with a voltage range of 10-14VDC , (nominal)1 Amp @12VDC Max.

Dimensions	139.70 mm x 209.60 mm x 33.20 mm (5.50 in x 8.25 in x 1.31 in)
Compatible power supply	Compatible plug-in transformers for use with the RFRP2 repeater: – WR9QE1000A00N6WG3150 - 12V, 1A power supply with NAM blade. (S/N: F.01U.398.526) For installations other than the U.S., transformers must meet the country-specific requirements.
Compatible blade kit	– Q-KIT-INTL-6-WH-RB - International blades for 12V, 1A. (S/N: F.01U.398.527)
Power/voltage	12 VDC, 1 A
Standby battery	This component is internal and not user replaceable. (3.6 VDC, 3180 mA)
Typical current draw	45 mA
Temperature (operating)	Charging range: +10°C to +45°C (+50°F to +113°F) Functional range: 0° C to +49° C (+32° F to +120° F )
Relative humidity	0% to 93% (non-condensing)
Device testing	To ensure proper functionality, the device must be tested at least once every year by an installer.
Wall and cover tamper switch	Transmits a tamper signal when someone removes the device from its base or pulls it away from the wall.
Frequency	433.42 MHz

**4.1.4 LEDs**

Refer to the external LED indicator to get operational status.

LED Condition	Pattern Description
On (Normal)	– Indicates the repeater is functioning normally.
Off	– Indicates there is a power failure to the repeater, or that the receiver is not wired correctly.
Continuous Flash: 1 sec rate for 5 sec	– Indicates the repeater is being powered up, and conducting manufacturing test initializations.
Continuous Flash: A 3-pulse signal, followed by a short delay after the 3 <sup>rd</sup> pulse	– Indicates the repeater has experienced a low battery condition.
Continuous Flash: A 2 flash pattern continuous pulse between On and Off states with a short delay after the 2 <sup>nd</sup> pulse	– Indicates an AC power failure is detected. – A communication failure within internal hardware components inside the receiver

Tab. 4.4: LED descriptions

## 4.2

### RFRP

#### Redundant Communication verification process

1. Build a network of repeaters.
2. Remove AC and battery power from one repeater. Removing the repeater from the mounting plate disconnects AC and battery power.
3. Start all other repeaters by removing and reinserting the repeater back onto the mounting plate.
4. Make sure all repeaters have “good” signal strength displayed in RPS or from the control panel keypad.
5. Re-apply the AC and battery power to the current repeater.
6. Repeat steps 2-5 until all repeaters in your environment have gone through the verification process and a redundant communication path is confirmed.
7. Make sure all other devices operate and report correctly, and have good signal strength.

This concludes the redundant communication verification process.

#### 4.2.1

#### Installation considerations

Use the provided anchors and screws to mount the repeater in locations accessible for future maintenance. Mount the repeater onto a wall.



#### Notice!

Mount the repeater in a location away from metal objects. Metal objects (duct work, wire mesh screens, boxes) reduce RF range

## 4.2.2 Wiring considerations



**Notice!**

Do not install long cable runs next to high-current power feeds. Keep cable lengths as short as possible to minimize noise pickup.

Ensure that the wiring used meets the following specifications:

- Two-conductor unshielded wire.
- The minimal requirement for wire length is 1.83 m (6 ft) from the repeater.

## 4.2.3 Specifications

Dimensions	139.70 mm x 209.60 mm x 31.80 mm (5.50 in x 8.25 in x 1.25 in)
<p>Compatible plug-in transformers for use with the RFRP-A repeater within US installations: These transformers are approved by UL:</p> <ul style="list-style-type: none"> <li>- BOSCH CX4010 Plug-in Transformer – (F.01U.020.504) primary rated 110 VAC primary voltage input, 18 VAC, 22 VA</li> <li>- BOSCH D1640 Plug-in Transformer – (4.998.125.832) primary rated 16.5 VAC, 40 VA</li> <li>- MG Electronic (MGT-1640), primary rated 120 VAC, 60 Hz, 0.48 Amps, secondary rated 16.5 VAC, 40 VA</li> <li>- Codex (SEP-1640), primary rated 120 VAC, 60 Hz, 0.48 Amps, secondary rated 16.5 VAC, 40 VA</li> <li>- TDC Part No (DA-22-18), primary rated 120 VAC, 60 Hz, secondary rated 18 VAC, 1.22 Amps, 22 VA</li> </ul> <p>For installations other than the U.S., transformers must meet the country-specific requirements.</p>	
Power/voltage	16.5 V(~) to 18 V(~), 40 VA
Standby battery	This component is internal and not user replaceable.
Typical current draw	60 mA
Wire gauge	0.65 mm (22 AWG) to 2.0 mm (18 AWG)
Temperature (operating)	Functional range: -10°C to +49°C (+14°F to +120°F) UL only: 0° C to +49° C (+32° F to+120° F
Relative humidity	0% to 93% (non-condensing)
Device testing	To ensure proper functionality, the device must be tested at least once every year by an installer.
Wall and cover tamper switch	Transmits a tamper signal when someone removes the device from its base or pulls it away from the wall.
Frequency	433.42 MHz

**Table 4.5: Specifications**

## 4.2.4 LEDs

Refer to the external LED indicator to get operational status.

LED Condition	Pattern Description
On (Normal)	– Indicates the repeater is functioning normally.
Off	– Indicates there is a power failure to the repeater, or that the receiver is not wired correctly.
Continuous Flash: 1 sec rate for 5 sec	– Indicates the repeater is being powered up, and conducting manufacturing test initializations.
Continuous Flash: A 3-pulse signal, followed by a short delay after the 3 <sup>rd</sup> pulse	– Indicates the repeater has experienced a low battery condition.
Continuous Flash: A 2 flash pattern continuous pulse between On and Off states with a short delay after the 2 <sup>nd</sup> pulse	– Indicates an AC power failure is detected. – A communication failure within internal hardware components inside the receiver

**Tab. 4.6: LED descriptions**

## 5 RADION glassbreak

The RADION glassbreak is a wireless transmitter used for detecting breaking glass. Throughout this document, the term “glassbreak” refers to glass break.

Features include:

- Monitored battery status

Dimension	101.42 mm x 112.90 mm x 35.00 mm (3.99 in x 4.44 in x 1.38 in)		
Power/Voltage	Battery/CR123A, 3 VDC (  ) Power source type: C Low battery level: 2.15V		
Battery replacement	Duracell PC1500, Duracell DL123A, Lithium, Panasonic CR123A Lithium, or Sanyo CR123A Lithium. Check your battery yearly to ensure proper functionality.		
Battery life	Up to 5 years		
Device testing	To ensure proper functionality, the device must be tested at least once every year.		
Acoustic Capabilities	Glass types and thickness	<b>Type</b>	<b>Thickness</b>
		Plate	2.4 mm to 6.4 mm (3/32 in to 1/4 in)
		Tempered	3.2 mm to 6.4 mm (1/8 in to 1/4 in)
		Laminated	3.2 mm to 6.4 mm (1/8 in to 1/4 in)
		Wired	6.4 mm (1/4 in)
	Minimum pane size for all types of glass	1.2 m (4 ft)	
Microphone	Omni-directional 360° electret		
Operating Temperature	Functional range: -10°C to +49°C (+14°F to +120°F) UL only: 0° C to +49° C (+32° F to +120° F)		
Relative Humidity	0% to 93% (non-condensing)		
Wall and Cover Tamper Switch	Transmits a tamper signal when someone removes the device from its base or pulls it away from the wall.		
Frequency	433.42 MHz		

Tab. 5.7: Specifications

### 5.1 Installation considerations

For the best detector performance, select a mounting location that is:

- Mounted on the ceiling within a maximum range of 20 ft (6 m)
- For armor-coated glass installations, mount the sensor no more than 12 ft (3.65 m) from the glass
- Mount the detector in the direct line of sight of the glass to be protected

- On an opposite, or adjoining wall, within a range of 20 ft (6 m) for plate, tempered, laminated, and wired glass
- In a suitable environment: temperature between -18 and 50° C (0 and 120° F); and humidity between 10 and 90% non-condensing

Avoid mounting the detector in:

- Glass airlocks and glass vestibule areas
- Humid rooms
- Small utility rooms
- Rooms with noisy equipment (white noise) such as air compressors, bells, and power tools
- Rooms smaller than 10 ft x 10 ft (3 m x 3 m)
- Rooms with lined, insulating, or sound suppressing drapes
- A corner of a room

Avoid locations that expose the detector to possible false-alarm sources such as:

- Glass airlocks and vestibule areas;
- Kitchens;
- Corner mounting;
- Residential car garages;
- Stairwells
- Bathrooms; and
- Small acoustically live rooms



#### Notice!

Glassbreak detectors are intended only as a component of a perimeter protection system. Use glassbreak detectors in conjunction with motion detectors.

## 5.2

### Testing

Test the detector at least once yearly. Use the Sentrol 5709C hand-held tester to enter the sensor into test mode and to test the alarm.

#### Test the sensor alarm

To test the sensor functionality, enter the detector into test mode. In normal mode, the sensor does not generate an alarm on sound signals from the tester unless the tester is held next to the sensor.

Each time the sensor alarms, it also goes into test mode for one minute.

Initiating test mode with the Sentrol 5709C hand-held tester:

1. Set the tester for tempered or laminated glass, unless the protected glass is plate glass.
2. Hold the tester on top of the detector.
3. Activate the tester. The detector alarms and goes into test mode for one minute. During test mode, the LED blinks continuously. To extend test time, activate the tester within the range of the sensor at least once each minute.

Performing the alarm test with Sentrol 5709C hand-held tester:

1. Hold the tester near the surface of the glass to be protected and aim the speaker at the sensor. Be sure the tester is at the point on the glass farthest from the detector.



#### Notice!

If blinds or drapes are present, test the area by holding the hand-held tester behind the closed blinds or drapes.



2. Press the test button on the tester. The LED on the detector stays on for 4 seconds to indicate the glass is within detection range of the sensor. If the LED does not stay in a solid state momentarily, but continues to blink, adjust the positioning of the detector so that it is closer to the window, and re-test. Check the battery strength of the hand-held testing device before the test.

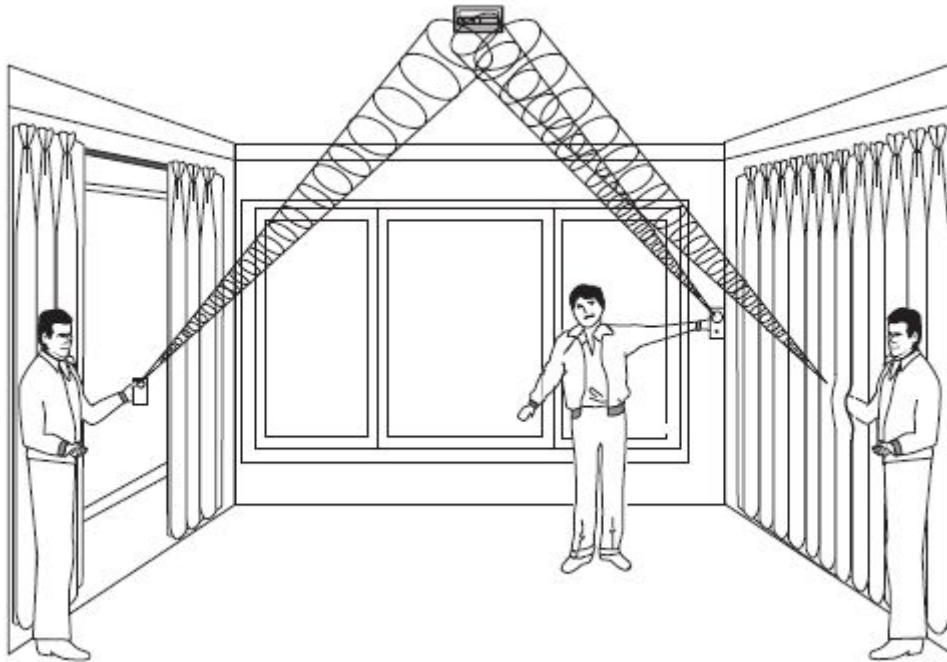

**Figure 5.1:** Testing behind curtains

The detector switches from test mode to normal mode after at least 1 minute of silence from the hand-held tester.



**Notice!**

When the detector is in normal mode, the LED is off unless a loud sound is detected.

Room acoustics can artificially extend the range of a glassbreak sensor. The specified sensor range is for worst-case conditions. While the sensor likely functions at a greater range, it might not detect a low volume breaking sound, or room acoustics might change at a later point in time. Do not exceed the rated range of the sensor, regardless of what the tester shows.

**Test the sensor operability**

When the detector is in normal mode, the LED is off unless a loud sound is detected.

Therefore, to ensure the glassbreak has power and that the microphone is functional, perform a simple hand clap test.

To perform a hand clap test, simply clap your hand loudly under the sensor. Verify the LED blinks twice.

**5.3**

**Low battery**

When a low battery state is detected, the detector measures the battery, and sends a report to the receiver/control panel.

## 5.4 **Wall Tamper Tab**

Use the wall tamper tab to activate an alarm when the glass break has been removed from the wall.

## 5.5 **Maintenance**

Clean the cover with a damp (water) cloth as needed to keep it free of dust and dirt. Always test the sensor after cleaning it.

## 6 RADION TriTech

The RADION TriTech is a motion detector which uses artificial intelligence to detect motion and provide immunity to false alarms. An integral RF transmitter reports low battery and tamper status, and sends a supervisory signal to the control panel. Features include:

- 11m x 11m (35 ft by 35 ft) coverage
- Flexible mounting height
- Compatible with Bosch RADION wireless systems
- Draft and Insect immune
- Cover activated tamper indication. Optional wall-activated tamper is included

Dimension	138.00 mm x 72.00 mm x 64.00 mm (5.43 in x 2.83 in x 2.52 in)
Relative humidity	0% to 93%, (non-condensing)
Temperature (operating)	Functional range: -10°C to +49°C (+14°F to +120°F) UL only: 0 ° C to +49 ° C (+32 ° F to+120 ° F)
Internal coverage directionality	Vertical: -4° to -10°
Sensitivity selection	Field selectable for standard or intermediate sensitivity
Power/voltage	Four AA Alkaline batteries, 1.5 VDC (— — — —). 1.5 VDC x 4 = 6 VDC total. Power source type: C Low battery level: 3.6V
Battery replacement	Duracell MN1500, Panasonic AM-3PIX. Check your battery yearly to ensure proper functionality.
Battery life	Up to 5 years
Device testing	To ensure proper functionality, the device must be tested at least once every year by an installer.
Wall and cover tamper switch	Transmits a tamper signal when someone removes the device from its base or pulls it away from the wall.
Frequency	433.42 MHz

**Table 6.8: Specifications**

### 6.1 Mounting height and range adjustment

Loosen the vertical adjustment screw. Adjust the board to the desired angle. Choose mounting height and desired range, and set the vertical angle. Reference the table below for proper height and adjustment values.

Mounting height	Range	
	6.1 m (20 ft)	10.7 m (35 ft)
2 m (6.5 ft)	-7°	-5°
2.1 m (7.0 ft)	-9°	-6°

2.4 m (8.0 ft)	-10°	-7°
----------------	------	-----

**Tab. 6.9: Mounting height**



**Notice!**

The mounting height must be 2 m (6.5 ft) and the vertical angle must be set at -5° for installations containing pets.

The vertical adjusting screw must be securely tightened after setting the angle.

## 6.2 Sensitivity settings

**Standard sensitivity**

Use this setting when pets are present in the monitored area. Standard sensitivity provides excellent detection performance and is the least sensitive to false alarms.

**Intermediate sensitivity**

Only use this setting in non-pet installations with minimal environmental disturbances. Intermediate sensitivity provides the highest level of detection performance.

## 6.3 Walk testing



**Notice!**

To maximize battery life, the LED elements do not activate unless the unit is in the Walk Test mode.

Perform a walk test to determine the boundaries of the coverage area. Perform this test at the time of installation and monthly thereafter. To ensure continual daily operation, instruct the end user to walk through the far end of the coverage pattern. This ensures an alarm output prior to arming the system.

Start Walk Test mode from the detector. Insert a slotted screwdriver to open the detector cover and then close the detector cover to start a 90-sec Walk Test mode.



**Notice!**

In the normal operating mode, an alarm can be transmitted only after three (3) minutes have passed since the previous alarm restoral. This 3 minute lockout time reduces unnecessary RF transmissions in high traffic areas, thereby extending battery life.

During this test mode, motion detected within the detector’s coverage area causes a transmitted alarm and LED activation. Each alarm will also extend the Test Mode. Watch for the green LED to indicate the edges of the Microwave pattern. Adjust as necessary. Please reference the LED table below for LED descriptions.

LED Condition	Cause
Steady LED	PIR activation (Walk Test)
Steady green	Microwave activation
Steady blue	Alarm signal
Flashing blue	Warm-up period after power-up

LED Condition	Cause
No LED upon initial power up	PIR failure. Replace unit.

**Tab. 6.10: LED description**

Walking Testing the system

1. Start at the pattern’s expected boundary and walk across the pattern moving closer to the detector. Set the adjustment as low as possible for proper catch performance.

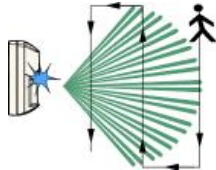

2. Adjust the Microwave Range Adjustment Potentiometer to as low a setting as possible for proper catch performance.

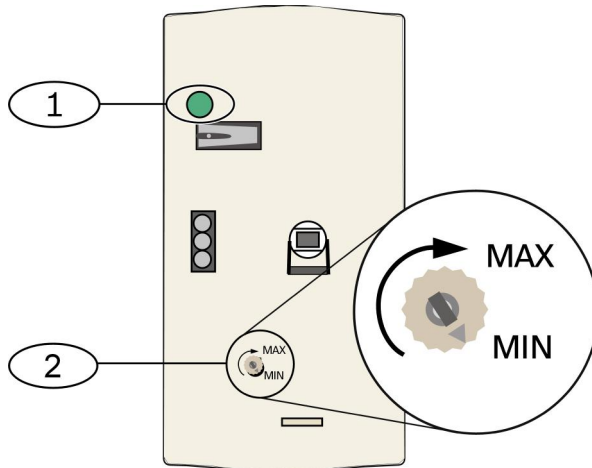

**Figure 6.1:** Sensitivity settings

Callout	Description
1	Alarm LED (blue, green, or red)
2	Microwave Range Adjustment Potentiometer

3. At each pass, observe the color on the Alarm LED (refer to the Sensitivity settings figure above).
4. Walk test from the opposite direction to determine the coverage pattern boundaries from both sides.
5. When walk test is completed, the detector returns to normal operation after 90 sec of inactivity.

## 7 RADION PIR

The RADION PIR is a high performance PIR motion detector that uses advanced signal processing. An integrated wireless transmitter sends a battery report with each transmission, and transmits a supervisory signal to the control panel. Features include:

- 12 m x 12 m (40 ft x 40 ft) coverage
- Flexible Mounting Height

Dimensions	111.00 mm x 60.00 mm x 43.00 mm (4.40 in x 2.40 in x 1.70 in)
Relative humidity	0% to 93%, non-condensing
Temperature (operating)	Functional range: -10°C to +49°C (+14°F to +120°F) UL only: 0° C to +49° C (+32° F to+120° F)
Power/voltage	One CR123A Lithium battery, 3 VDC (==) ) Power source type: C Low battery level: 2,15V
Battery replacement	Duracell DL123A , Panasonic CR123A, or Sanyo CR123A. Check your battery yearly to ensure proper functionality.
Battery life	Up to 5 years
Device testing	To ensure proper functionality, the device must be tested at least once every year by an installer.
Wall and cover tamper switch	Transmits a tamper signal when someone removes the device from its base or pulls it away from the wall.
Frequency	433.42 MHz

**Table 7.11: Specifications**

### 7.1 Walk testing

Perform a walk test to determine the boundaries of the coverage area.

Insert a slotted screwdriver into the designated hole to open the cover and then close the detector cover to start a 90-sec Walk Test mode.

During this test mode, motion detected within the detector's coverage area causes a transmitted alarm and LED activation. Each alarm will also extend the Test Mode. Adjust as necessary.



#### Notice!

Excessive use of the Walk Test Mode may reduce battery life. Use only for initial setup and maintenance testing.



#### Notice!

In the normal operating mode, an alarm can be transmitted only after three (3) minutes have passed since the previous alarm restoral. This 3 minute lockout time reduces unnecessary RF transmissions in high traffic areas, thereby extending battery life.

Refer to the LED table below for LED descriptions.

LED condition	Cause
Steady blue	PIR activation (Walk Test)
Flashing blue	Warm-up period after power-up
Flashing blue (four-pulse sequence)	PIR failure. Replace unit.

**Tab. 7.12: LED description**

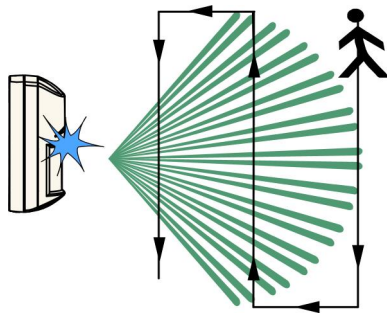

**Figure 7.1: Walk test**

1. Start at the pattern's expected boundary and walk across the pattern moving closer to the detector (refer to the Walk test figure above).
2. While the detector is in the Walk Test Mode, turn ON all heating and air conditioning sources which would normally be active during the protection period. Stay away from the sensor and outside the coverage pattern and watch for alarms.
3. The LED flashes at the completion of a 90-sec span of time, indicating that the Walk Test mode is ending. This occurs when there is no activity in the sensor's coverage pattern during the 90-sec interval.
4. When walk testing is completed, the detector returns to normal operation after 90 seconds of inactivity.

## 8 RADION PIR C

The RADION PIR with curtain detecting capability is a high performance curtain PIR motion detector that uses advanced signal processing to provide outstanding catch performance and unsurpassed false alarm immunity. The detector contains an integrated RF transmitter. The transmitter sends a battery report with each transmission, and transmits a supervisory signal to the control panel. Features include:

- 12 m x 1.5 m (40 ft x 5 ft) curtain coverage
- Flexible Mounting Height

Dimensions	111.00 mm x 60.00 mm x 43.00 mm (4.40 in x 2.40 in x 1.70 in)
Relative humidity	0% to 93%, non-condensing
Temperature (operating)	Functional range: -10°C to +49°C (+14°F to +120°F) UL only: 0° C to +49° C (+32° F to+120° F)
Power/voltage	One CR123A Lithium batteries, 3 VDC (====) Power source type: C Low battery level: 2,15V
Battery replacement	Duracell DL123A, Panasonic CR123A, or Sanyo CR123A. Check your battery yearly to ensure proper functionality.
Battery life	Up to 5 years
Device testing	To ensure proper functionality, the device must be tested at least once every year by an installer.
Wall and cover tamper switch	Transmits a tamper signal when someone removes the device from its base or pulls it away from the wall.
Frequency	433.42 MHz

**Tab. 8.13: Specifications**

### 8.1 Walk testing

Perform a walk test to determine the boundaries of the coverage area.

Insert a slotted screwdriver into the designated hole to open the cover and then close the detector cover to start a 90-sec Walk Test mode.

During this test mode, motion detected within the detector's coverage area causes a transmitted alarm and LED activation. Each alarm will also extend the Test Mode. Adjust as necessary.



**Notice!**

Excessive use of the Walk Test Mode may reduce battery life. Use only for initial setup and maintenance testing.



**Notice!**

In the normal operating mode, an alarm can be transmitted only after three (3) minutes have passed since the previous alarm restoral. This 3 minute lockout time reduces unnecessary RF transmissions in high traffic areas, thereby extending battery life.



Refer to the LED table below for LED descriptions.

LED condition	Cause
Steady blue	PIR activation (Walk Test)
Flashing blue	Warm-up period after power-up
Flashing blue (four-pulse sequence)	PIR failure. Replace unit.

**Tab. 8.14: LED description**

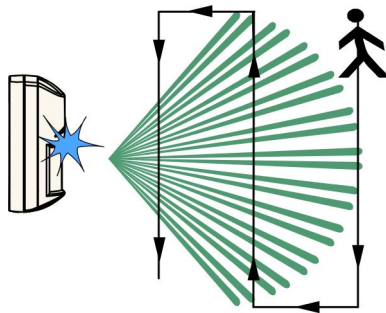
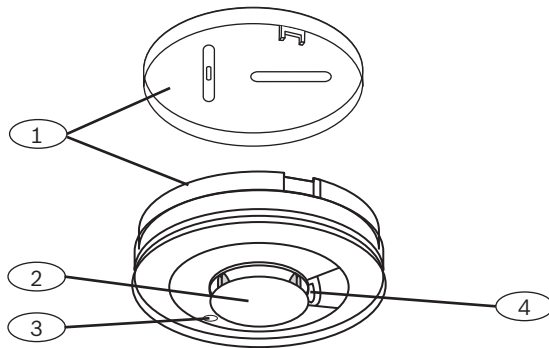

**Figure 8.1: Walk test**

1. Start at the pattern's expected boundary and walk across the pattern moving closer to the detector (refer to the Walk test figure above).
2. While the detector is in the Walk Test Mode, turn ON all heating and air conditioning sources which would normally be active during the protection period. Stay away from the sensor and outside the coverage pattern and watch for alarms.
3. The LED flashes at the completion of a 90-sec span of time, indicating that the Walk Test mode is ending. This occurs when there is no activity in the sensor's coverage pattern during the 90-sec interval.
4. When walk testing is completed, the detector returns to normal operation after 90 seconds of inactivity.

## 9 RADION smoke RFSM2

This smoke detector includes a photoelectric sensor that senses low energy smoke particles. The detector is sensitive to all domestic fire types but is especially sensitive to smoldering fires and is ideal for bedrooms and children's rooms. The RFSM2-A smoke detector also includes a fixed and rate-of-rise heat sensor for fire detection.



Callout - Description
1 - Mounting plate
2 - Test/Silence button
3 - LED
4 - Sounder

For more information, refer to the RADION Life Safety Installation Manual P/N: F.01U.361.555.

# 10 RADION CO

This carbon monoxide detector includes a 10 year electrochemical sensor that senses the presence of toxic carbon monoxide gases. A red LED flashes when carbon monoxide is detected. When higher levels are detected, the alarm sounds.

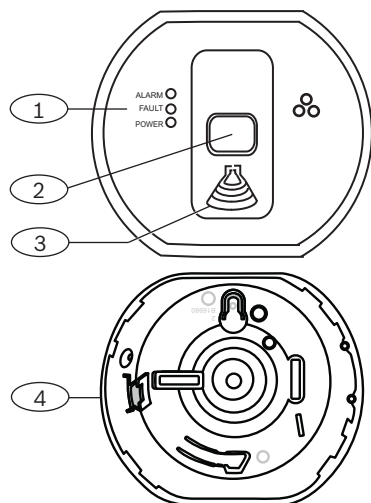

Callout - Description
1 - LEDs
2 - Test/Silence button
3 - Sounder
4 - Mounting plate

For more information, refer to the RADION Life Safety Installation Manual P/N: F.01U.361.555.

# 11 RADION heat

This heat detector senses a rise in temperature caused by fire. Ideal installation locations for this detector include kitchens and other areas where there is normally some level of smoke or fumes and where smoke alarms might be subjected to false alarms due to an excessively dirty environment.

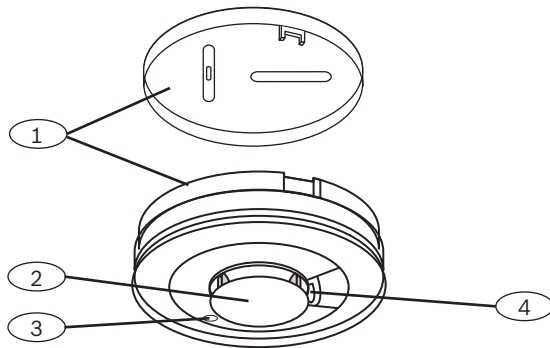

Callout - Description
1 - Mounting plate
2 - Test/Silence button
3 - LED
4 - Sounder

For more information, refer to the RADION Life Safety Installation Manual P/N: F.01U.361.555.

## 12 RADION smoke

The RADION smoke is a non-latching wireless smoke detector that sends an alarm signal to the receiver.

The following features include:

- A visual status LED
- A built-in sounder for alarm alerts
- Under normal conditions, the red LED flashes once every 8 sec while the sensor monitors the surrounding environment. When the sensor detects smoke, the LED changes from flashing to steady ON and the sounder produces a loud, continuous tone. Refer to the LED table for more information.

Replaceable optical chamber	For easy maintenance
Power/voltage	Two CR123A Lithium batteries, 3 VDC (====) Power source type: C Low battery level: 2.15V
Current draw	Standby: 45 uA Alarm: 70 mA
Battery replacement	Duracell DL123A, Panasonic CR123A, or Sanyo CR123A. Check your batteries yearly to ensure proper functionality.
Battery life	Minimum of 5 years or greater
Device testing	To ensure proper functionality, the device must be tested at least once every year.
Sensitivity	0.14+/- 0.04 bM/m (0.97 – 2.99%/ft obscuration – RFSM-A only)
Temperature (operating)	Functional range: -10° C to +49° (+14° F to +120° F) UL only: 0° C to +49° C (+32° F to +120° F)
Relative humidity	0% to 93% (non-condensing)
Cover and wall tamper switch	Transmits a tamper switch signal when the detector is removed from its base, or the unit is pulled away from the wall.
Drift compensation adjustment	1.64%/m (0.5%/ft) maximum
Sounder	85 dBA at 3 m
Self-diagnostics feature	Monitors detector sensitivity and operational status.
Frequency	433.42 MHz

**Tab. 12.15: Specifications**

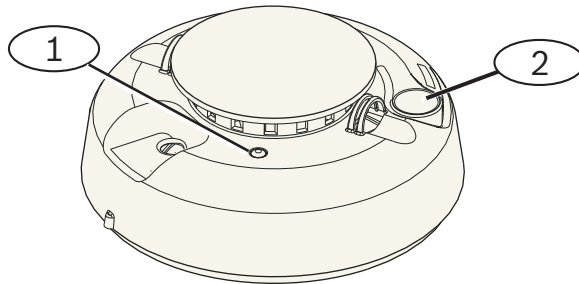

Figure 12.1: Smoke detector

1	High intensity LED
2	Test/Silence button

### 12.1 Battery replacement

Under normal conditions, the LED normally flashes every 8 sec to indicate normal operating conditions. Replace the battery when the LED stops flashing, and the sensor chirps every 45 sec.

Silence the low battery trouble chirps for 24 hr by pushing the **Test/Silence** button. Refer to the Smoke detector illustration for locating the **Test/Silence** button.

### 12.2 Smoke test

Test smoke detectors annually by using a listed aerosol smoke tester to simulate an alarm. Follow the instructions on the can.

The LED should remain ON while the detector provides a continuous tone. The detector automatically resets when smoke is no longer present. A detector that fails to activate with the smoke test might require cleaning or replacement.



**Notice!**

To avoid a fire department dispatch, contact central monitoring station, or put the system into Test mode before activating the detector using this method.

### 12.3 Sensitivity test



**Notice!**

The control panel recognizes Test Mode as a test. It does not send an alarm.

The detector includes a Sensitivity Level Test mode for determining the detector’s sensitivity:

1. Press and hold the **Test/Silence** button for 4 sec. The LED flashes 1 to 9 times.
2. Count the number of LED flashes and use the Smoke detector sensitivity conditions table to determine the status of the detector’s sensitivity and the recommended action.

Flashes	Action Recommended
1	Self-diagnostics failure. Return detector for service or replacement.

Flashes	Action Recommended
2 to 3	Detector is becoming insensitive. Clean detector and re-test. If error persists, replace the detector.
4 to 7	Detector is within normal sensitivity settings.
8 to 9	Detector is becoming too sensitive. Confirm that the smoke chamber is snapped down securely. Clean the sensor and re-test.

Tab. 12.16: Smoke detector sensitivity conditions

## 12.4 Test/Silence button

Refer to the RADION smoke detector illustration for location of the **Test/Silence** button.

- Testing. Press the Test/Silence button for 4 sec. The detector performs a Sounder test and a Sensitivity test.
- Silence alarm. Press to silence the sounder during an alarm. After a few minutes, the sounder and alarm resume if smoke is still present.

### Remote monitoring station alarm test

Press the button for fifteen (or 20) seconds to send a fire alarm signal to the remote monitoring station.



### Notice!

To avoid a fire department dispatch, contact the remote monitoring station or put the control panel into the corresponding test mode before performing this test.

## 12.5 LED

LED	Status
Flashing	Flashes every 8 sec under normal operation.
ON	Detects smoke, sending an alarm.
OFF	Malfunction, replace the batteries, clean the detector, or replace the optical chamber as required.

Tab. 12.17: LED

## 12.6 Clean the detector and replace the optical chamber

Clean the detector cover with a dry or damp cloth as needed to keep it free from dust and dirt. Clean the detector interior at least yearly.

Cleaning the detector:

1. Remove the detector from the mounting base.
2. Remove the batteries.
3. Slide a slotted screwdriver into the slot on the detector cap and gently push down to pry off the cap.

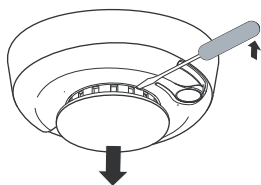

**Figure 12.2:** Remove the detector cap

4. Squeeze the optical chamber where indicated and pull it up and away from the detector.

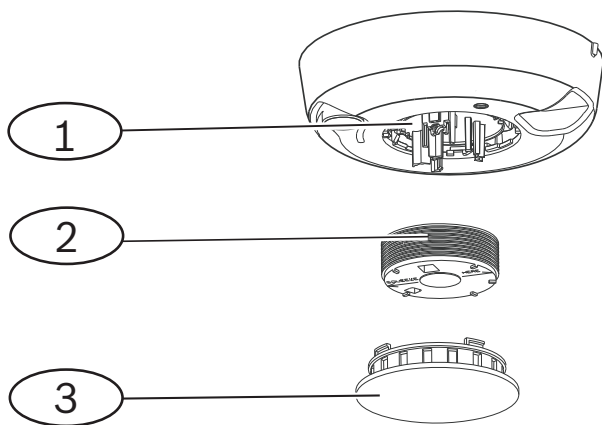

**Figure 12.3:** Remove the detector cap

1	Optical base
2	Optical chamber
3	Alarm cap

5. Use compressed air or a soft-bristled brush to remove dust and dirt from the smoke chamber base.
6. Align the optical chamber with the base and snap down into place.
7. To attach the detector cap, line the cap up with the detector, press the cap onto the detector, and turn clockwise to snap it firmly into place.
8. Observing the proper polarity, install the batteries and the battery cover. If the batteries are not installed properly, the detector will not fit onto the mounting base. Ensure that the batteries are properly installed.
9. Mount the detector onto the mounting base.
10. Test the detector’s sensitivity.



## 13 RADION contact SM

The RADION contact SM door/window contact is a standard surface-mount wireless transmitter device used for monitoring doors and windows.

Features include:

- An internal reed switch
- A cover and wall tamper switch

Power/voltage	One AAA Lithium battery, 1.5 VDC (  ) Power source type: C Low battery level: 0.9V
Battery replacement	Energizer L92. Check your battery yearly to ensure proper functionality.
Battery life	Up to 5 years
Device testing	To ensure proper functionality, the device must be tested at least once every year by an installer.
Dimensions (transmitter)	19.50 mm x 82.55 mm x 12.80 mm (0.76 in x 3.25 in x 0.50 in)
Dimensions (magnet)	24.5 mm x 18.5 mm x 12.5 mm (0.97 in x 0.72 in x 0.49 in)
Temperature (operating)	Functional range: -10°C to +49°C (+14°F to +120°F) UL only: 0° C to +49° C (+32° F to +120° F)
Relative humidity	0% to 93% (non-condensing)
Wall and Cover Tamper Switch	Transmits a tamper signal when someone removes the device from its base or pulls it away from the wall.
Frequency	433.42 MHz

**Tab. 13.18: Specifications**

### 13.1 Installation considerations

You have a variety of installation options to consider when installing the device. You must acknowledge the unique installation approach prior to installation. Some installation considerations include:

- Suitable surfaces for installation include wood, steel, and aluminum.
- The location of the magnet and transmitter in relationship to the door/window frame dimensions. Verify you have proper clearance with the latch of the window or door you are installing the device onto. Failure to do so will make it extremely difficult to access and open the device for maintenance purposes.
- In some cases, you might need an additional spacer when installing the transmitter and magnet in the corner of a recessed door or window frame to close the gap in height between the magnet and transmitter.
- For additional security, you can use an adhesive with the screws to secure the transmitters and magnets during installation.

- When installing the magnet, verify that the notches in the magnet base, line up with the notches in the transmitter base, otherwise the magnet and transmitter do not function effectively.
- When installing the magnet base, install the face of the magnet base flush to the surface edge of the installation location. This prevents damage to the magnet plastic base whenever a window or door is opened.
- Adhere to the distances prescribed in the graphical table found in the graphical Installation and Operation Guide when installing the magnet adjacent to the transmitter.

**How to read the Graphical Magnet Distances table**

Contained in the RADION contact SM Installation Guide is a graphical table along with the X □ Y □ Z coordinates graphic. Use the table in conjunction with the graphic to determine desired distances between the magnet and the transmitter based on the type of installation (wood or metal).

**Notice!**

The content in the Installation Guide table applies to EN installations.

# 14 RADION contact RM

The RADION contact RM is a recessed-mounted wireless transmitter device used for monitoring doors and windows. Features include:

- Self-contained transmitter with magnetic reed switch
- Tamper protection
- Recessed mounting on doors or windows

Power/voltage	One AAA Lithium battery, 1.5 VDC (  ) Power source type: C Low battery level: 0.9V
Battery replacement	Energizer L92. Check your battery yearly to ensure proper functionality.
Battery life	Up to 5 years
Device testing	To ensure proper functionality, the device must be tested at least once every year by an installer.
Dimensions (transmitter)	19.00 mm x 104.80 mm (0.75 in x 4.12 in)
Dimensions (magnet)	22 mm x 28 mm x 15 mm (0.87 in x 1.10 in x 0.59 in)
Relative humidity	0% to 93%, non-condensing
Temperature (operating)	Functional range: -10°C to +49°C (+14°F to +120°F) UL only: 0° C to +49° C (+32° F to+120° F)
Frequency	433.42 MHz

**Tab. 14.19: Specifications**

## 14.1 Installation considerations

You have a variety of installation options to consider when installing the device. You must acknowledge the unique installation approach prior to installation. Some installation considerations include:

- The installation of this device is suitable for wood surfaces. This device is not suitable for steel surfaces.
- The transmitter housing was designed to be open with a coin. Using a screwdriver may cause damage to the plastic top.
- When reinserting the PCB (battery and antenna assembly), verify that the PCB assembly fits into the grooves of the transmitter housing.
- When reinserting the plastic top, verify that the top fits into the designed grooves of the transmitter housing.
- When installing the transmitter in an overhead location, be mindful that the PCB assembly may fall out of the transmitter housing.
- The removal of the plastic flaps is optional, depending on your installation needs.
- For added security, you can use an adhesive with the screws to secure the transmitters and magnets.



**Notice!**

EN requirements

For further information regarding certified installations, please refer to EN product requirements.

**How to read the Graphical Magnet Distances table**

Contained in the recessed door/window contact Installation Guide is a graphical table along with the X-Y coordinates graphic. Use the table in conjunction with the graphic to determine desired distances between the magnet and the transmitter based on the type of installation.

# 15 RADION specialty

RADION specialty is a designed transmitter (bill trap) specifically used in financial or retail environments. It transmits a silent, wireless alarm signal without local notification (no LED activation) when a bill, or any other form of paper currency is removed from the transmitter – typically, the last bill in the bottom of a cash drawer.

Features include:

- Brief illumination of LED to signify armed and operational status
- Wall tamper alarm when removed from the cash drawer.

Dimensions	48.80 mm x 154.10 mm x 23.60 mm (1.92 in x 6.06 in x 0.93 in)
Power/voltage	1.5 VDC, Lithium (  ) Power source type: C Low battery level: 0.9V
Battery replacement	Energizer L92. Replace your battery yearly to ensure proper functionality.
Battery life	Up to 5 years
Device testing	To ensure proper functionality, the device must be tested at least once every year.
Relative humidity	Up to 93%, non-condensing
Temperature (operating)	Functional range: -10°C to +49°C (+14°F to +120°F) UL only: 0° C to +49° C (+32° F to+120° F)
Frequency	433.42 MHz

**Tab. 15.20: Specifications**

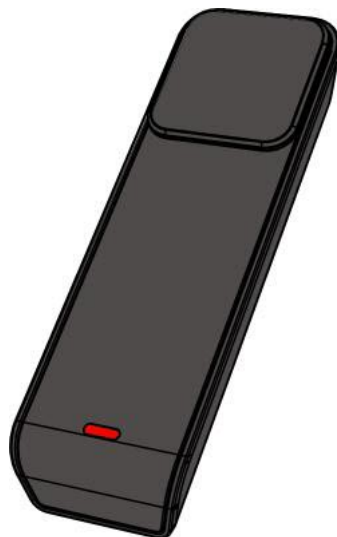

**Figure 15.1:** Specialty

## 15.1 Applications for this product

Usage of this product is to provide concealed protection against theft in a financial institution such as a bank, or in other commercial environments such as retail businesses and shops. In some cases, the cash drawer is removed from the teller or cashier station, and stored inside a bank vault at the close of each business day. In this scenario, the bank vault system is always armed, and the bill trap remains in a non-faulted condition. It is recommended to use the 3M double sided tape when inserting into the cash drawer.

In other occasions, the bill trap itself may be removed from the cash drawer at the end of a workers shift. In this situation, the bill trap unit will generate a tamper condition upon removal. In this type of application, it is important that the system must be configured such that the tamper does not generate a silent alarm. For this occasion, the hook and loop may be a more suitable mounting technique.

## 15.2 Installation consideration

During the installation process, use the self-adhesive Velcro strips located on the bottom of the bill trap base, to secure and stabilize the bill trap in the cash drawer. This is achieved by performing the following:

1. Separate the Velcro strips from one another.
2. Peel off the protective backing of the Velcro strips.
3. Press the two bottom sections of the Velcro onto the bottom of the cash drawer, in the desired location.
4. Line up and press down on the bill trap so that the Velcro on the bottom of the bill trap is aligned with the Velcro strips inside the cash drawer.



### Warning!

It is important to check the Velcro strips on a weekly basis for wear and replace when appropriate in order to prevent potential false alarms.

# 16 RADION universal transmitter

The RADION universal is a wireless detector used for monitoring doors, windows, and other dry contact devices.

Features include:

- A cover and wall tamper switch
- Single input with magnetic contact
- Ability to connect to an external detector

Dimensions (transmitter)	82.55 mm x 33.02 mm x 19.50 mm (3.25 in x 1.30 in x 0.76 in)
Dimensions (magnet)	24.50 mm x 18.50 mm x 12.50 mm (0.97 in x 0.72 in x 0.49 in)
Wire gauge	0.65 mm (22 AWG) to 1.5 mm (16 AWG)
Wiring distance	Maximum distance of 7.62 m (25 ft)
Power/voltage	Lithium battery, 3 VDC (  ) Power source type: C Low battery level: 2.15V
Battery replacement	One Duracell DL123A, or Panasonic CR123A, or Sanyo CR123A. Check your battery yearly to ensure proper functionality.
Battery life	Up to 5 years
Device testing	To ensure proper functionality, the device must be tested at least once every year by an installer.
Temperature (operating)	Functional range: -10°C to +49°C (+14°F to +120°F) UL only: 0° C to +49° C (+32° F to+120° F)
Relative Humidity	0% to 93% (non-condensing)
Terminal block	For connecting other dry contact devices such as another magnetic reed switch.
Wall and cover tamper switch	Transmits a tamper signal when someone removes the device from its base or pulls it away from the wall.
Frequency	433.42 MHz

**Tab. 16.21: Specifications**

### Single EOL Resistor Option

Use a 2.2 kΩ EOL resistor. Refer to the diagram below.

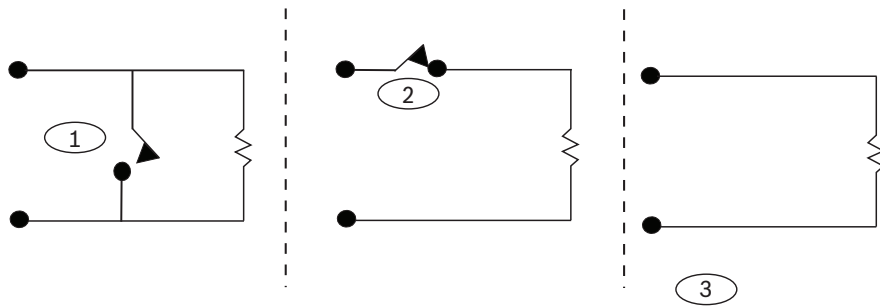

**Figure 16.1:** Single EOL resistor option

1	Normally-open (NO)
2	Normally-closed (NC)
3	Input disabled – no contact

## 16.1 Installation considerations

You have a variety of installation options to consider when installing the device. You must acknowledge the unique installation approach prior to installation. Some installation considerations include:

- The location of the magnet and transmitter in relationship to the door/window frame dimensions. Verify you have proper clearance with the latch of the window or door you are installing the device onto. Failure to do so will make it extremely difficult to access and open the device for maintenance purposes.
- In some cases, you might need an additional spacer when installing the transmitter and magnet in the corner of a recessed door or window frame to close the gap in height between the magnet and transmitter.
- On surface areas that are not conducive to mounting via the screws, you can secure transmitters and magnets using an industrial strength adhesive.
- When installing the magnet, verify that the notches in the magnet base, line up with the notches in the transmitter base, otherwise the magnet and transmitter do not function effectively.
- When installing the magnet base, install the face of the magnet base flush to the surface edge of the installation location. This prevents damage to the magnet plastic base whenever a window or door is opened.
- Adhere to the distances prescribed in the graphical table found in the graphical Installation and Operation Guide when installing the magnet adjacent to the transmitter.

### How to read the Graphical Magnet Distances table

Contained in the universal transmitter Installation and Operation Guide is a graphical table along with the X-Y-Z coordinates graphic. Use the table in conjunction with the graphic to determine desired distances between the magnet and the transmitter based on the type of installation (wood or metal).



#### Notice!

The content in the graphical table applies to EN installations.



## 16.2 Reed switch settings

Set the detector to enable or disable the reed switch.



**Notice!**

Please note, insert the jumper onto the pin prior to installing the battery. Failure to do so may result in unexpected operation of the device.

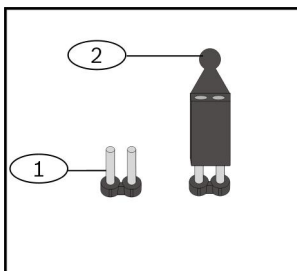

Figure 16.2: Reed switch

Callout	Description
1	No jumper disables the internal reed switch
2	Jumper on enables the internal reed switch

## 17 RADION keyfob

RADION keyfobs (two button and four button) are personal transmitters carried by the user that allow the user to remotely arm or disarm a security area.



### Notice!

RADION encrypted keyfobs

Use of the RADION encrypted keyfobs requires use of RADION receivers having the latest firmware version. Refer to the following tables for compatible receiver firmware versions.

Encrypted keyfobs	Non-encrypted keyfobs
RFKF-FBS-A (P/N: F.01U.313.183)	RFKF-FB-A (P/N: F.01U.263.964)
RFKF-TBS-A (P/N: F.01U.313.186)	RFKF-TB-A (P/N: F.01U.263.976)
Encrypted keyfobs	Non-encrypted keyfobs
RFKF-FBS (P/N: F.01U.313.182)	RFKF-FB (P/N: F.01U.253.609)
RFKF-TBS (P/N: F.01U.313.185)	RFKF-TB (P/N: F.01U.260.847)
Encrypted keyfobs	Non-encrypted keyfobs
RFKF-FBS-CHI (P/N: F.01U.313.184)	RFKF-FB-CHI (P/N: F.01U.253.626)
RFKF-TBS-CHI (P/N: F.01U.313.187)	RFKF-TB-CHI (P/N: F.01U.260.848)

Dimensions	63.70 mm x 35.50 mm x 13.00 mm (2.51 in x 1.40 in x 0.51 in)
Power/voltage	One Lithium battery (CR2032) 3 VDC Power source type: C Low battery level: 2.1V
Battery replacement	Panasonic CR2032, Duracell DL2032. Check your Battery yearly to ensure proper functionality
Battery life	Up to 5 years
Temperature (operating)	Functional range: -10°C to +49°C (+14°F to +120°F) UL only: 0° C to +49° C (+32° F to+120° F)
Relative humidity	0% to 93% (non-condensing)
Frequency	433.42 MHz

**Tab. 17.22: Specifications**



**Notice!**

Please note, the battery does not come installed. Refer to the specification table for the correct battery type when replacing an old battery.

**Keyfob buttons**

Refer to your control panel’s documentation to program the functions of the programmable buttons.

Pressing either the arm or disarm button causes the LED to flash for about 2 sec., indicating the keyfob sent commands to the control panel.



**Notice!**

Pressing the Arm and Disarm buttons in unison for 1 sec transmits a panic alarm.

**17.1**

**RADION keyfob FB**

The RADION keyfob FB four button keyfobs are designed for arming (lock icon) and disarming (unlock icon) the system remotely. You can configure the programmable buttons at the control panel for additional control functionality. To operate the programmable buttons, simply press and hold either button for at least one sec in order for the desired feature to work.

- Uniquely coded arm and disarm buttons
- Panic alarm
- LED indicator
- Programmable option buttons

The RFKF-FBS-CHI keyfob includes synchronized encryption and is compatible only with RADION receivers having firmware v1.3 or higher.

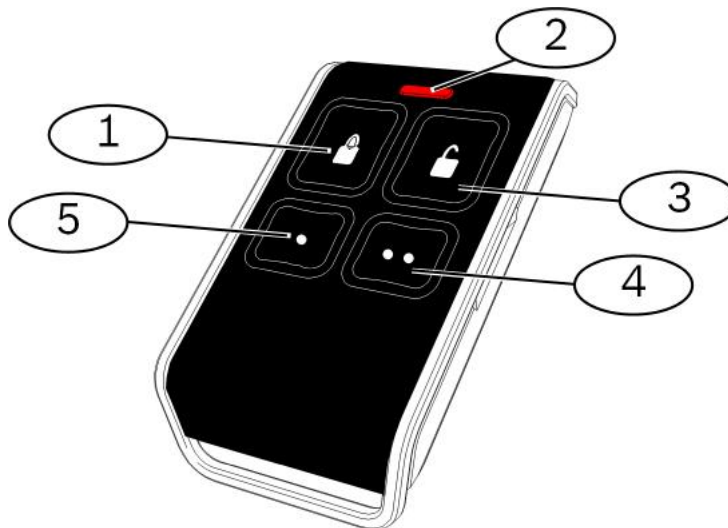

**Figure 17.1:** Keyfob buttons and LED

1	□ Arm button
2	□ LED

3 □ Disarm button
4 □ Programmable button
5 □ Programmable button

## 17.2 RADION keyfob TB

The RADION keyfob TB two button keyfobs are designed for arming (lock icon) and disarming (unlock icon) the system remotely. To operate these buttons, simply press and hold either button for at least one sec in order for the desired feature to work.

- Uniquely coded arm and disarm buttons
- Panic alarm
- LED indicator

The RFKF-TBS-CHI keyfob includes synchronized encryption and is compatible only with RADION receivers having firmware v1.3 or higher.

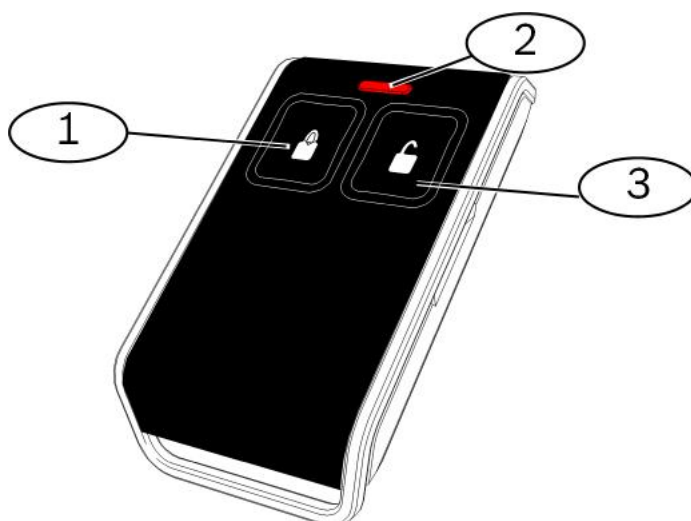

Figure 17.2: Keyfob buttons and LED

1 □ Arm button
2 □ LED
3 □ Disarm button

## 18 RADION panic FP

The RADION panic FP is a wireless, fixed-position detector used to signal a burglary in progress.

Features include:

- Cover and tamper switch
- Key to automatically reset the alarm

Consider the following when installing the detector:

- Mount on a flat surface.
- Mount in a fixed position under a counter or desk.
- Mount in a location that allows easy access for maintenance.







### Specification







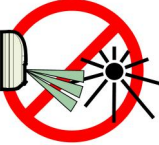
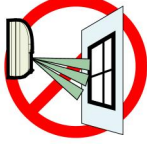
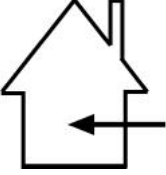

Dimensions	93 mm x 73 mm x 23 mm (3.66 in x 2.87 in x .90 in)
Power/voltage	1 Lithium battery 3 VDC Power source type: C Low battery level: 2.5V
Battery replacement	1 Duracell DL123A or Panasonic CR123A
Detector testing	Yearly by an installer
Temperature (operating)	Functional range: -10°C to +55°C (+14°F to +130°F) UL only: 0° C to +49° C (+32° F to+120° F)
Relative Humidity	0% to 93% (non-condensing)
Tamper switch	Transmits a tamper signal when an unauthorized person removes the detector from its base or attempts to remove the cover.
Frequency	433.42 MHz



# 19 Appendices

## Icons and symbols

Use the table below for descriptions of the icons and symbols used in the reference guide.

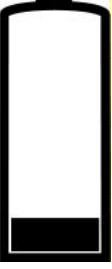
Description	Icon/symbol
Not pet friendly.	
Signifies that the item is the correct choice, selection, or location.	
Pet friendly (appropriate height and weights below graphic).	
Point away from rotating machines.	
Point away from objects that rapidly change temperature	
Do not mount the device that has direct exposure to sunlight.	
Do not point toward window.	
Intended for indoor use only.	
Electrostatic discharge symbol	

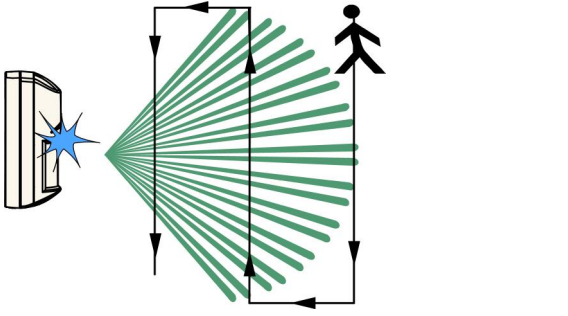
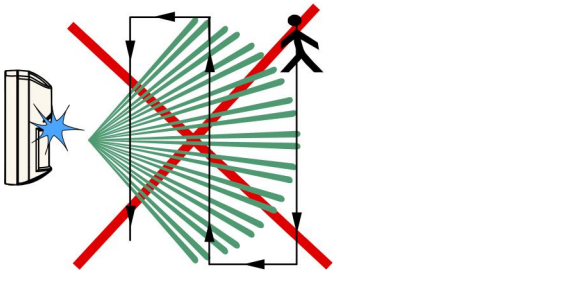
<p>Symbol against disposing batteries into the garbage</p>	
<p>Humidity range</p>	
<p>Temperature range</p>	
<p>Frequency range</p>	
<p>Duration of time</p>	
<p>Questions are answered in the reference guide.</p>	
<p>Universal sign for connecting or disconnecting power.</p>	
<p>Universal sign for connecting to a power source.</p>	
<p>Battery-related information.</p>	

<p>Perform a walk test</p>	 A diagram showing a sensor on a wall emitting a fan of green beams. A person is walking through the beams, indicated by a black stick figure and a path with arrows.
<p>Walk test has concluded</p>	 The same diagram as above, but with a large red 'X' over the entire scene, indicating the test is over.
<p>Device has wall tamper detection.</p>	 A warning icon consisting of a triangle with an exclamation mark and a silhouette of a person using a tool to tamper with a wall.











**Bosch Security Systems B.V.**

Torenallee 49

5617 BA Eindhoven

Netherlands

**[www.boschsecurity.com](http://www.boschsecurity.com)**

© Bosch Security Systems B.V., 2021